

CODIVERSIFICATION IN AN ANT-PLANT MUTUALISM: STEM TEXTURE AND THE EVOLUTION OF HOST USE IN *CREMATOGASTER* (FORMICIDAE: MYRMICINAE) INHABITANTS OF *MACARANGA* (EUPHORBIACEAE)

SWEE-PECK QUEK,^{1,2} STUART J. DAVIES,³ TAKAO ITINO,⁴ AND NAOMI E. PIERCE¹

¹Museum of Comparative Zoology, 26 Oxford Street, Cambridge, Massachusetts 02138

²E-mail: squek@oeb.harvard.edu

³Center for Tropical Forest Science–Asia Program, The Arnold Arboretum of Harvard University and The Smithsonian Tropical Research Institute, 22 Divinity Avenue, Cambridge, Massachusetts 02138

⁴Department of Biology, Faculty of Science, Shinshu University, Asahi 3-1-1, Matsumoto, Nagano 390-8621, Japan

Abstract.—We investigate the evolution of host association in a cryptic complex of mutualistic *Crematogaster* (*Decacrema*) ants that inhabits and defends *Macaranga* trees in Southeast Asia. Previous phylogenetic studies based on limited samplings of *Decacrema* present conflicting reconstructions of the evolutionary history of the association, inferring both cospeciation and the predominance of host shifts. We use cytochrome oxidase I (COI) to reconstruct phylogenetic relationships in a comprehensive sampling of the *Decacrema* inhabitants of *Macaranga*. Using a published *Macaranga* phylogeny, we test whether the ants and plants have cospeciated. The COI phylogeny reveals 10 well-supported lineages and an absence of cospeciation. Host shifts, however, have been constrained by stem traits that are themselves correlated with *Macaranga* phylogeny. Earlier lineages of *Decacrema* exclusively inhabit waxy stems, a basal state in the *Pachystemon* clade within *Macaranga*, whereas younger species of *Pachystemon*, characterized by nonwaxy stems, are inhabited only by younger lineages of *Decacrema*. Despite the absence of cospeciation, the correlated succession of stem texture in both phylogenies suggests that *Decacrema* and *Pachystemon* have diversified in association, or codiversified. Subsequent to the colonization of the *Pachystemon* clade, *Decacrema* expanded onto a second clade within *Macaranga*, inducing the development of myrmecophytism in the *Pruinosae* group. Confinement to the aseasonal wet climate zone of western Malesia suggests myrmecophytic *Macaranga* are no older than the wet forest community in Southeast Asia, estimated to be about 20 million years old (early Miocene). Our calculation of COI divergence rates from several published arthropod studies that relied on tenable calibrations indicates a generally conserved rate of approximately 1.5% per million years. Applying this rate to a rate-smoothed Bayesian chronogram of the ants, the *Decacrema* from *Macaranga* are inferred to be at least 12 million years old (mid-Miocene). However, using the extremes of rate variation in COI produces an age as recent as 6 million years. Our inferred timeline based on 1.5% per million years concurs with independent biogeographical events in the region reconstructed from palynological data, thus suggesting that the evolutionary histories of *Decacrema* and their *Pachystemon* hosts have been contemporaneous since the mid-Miocene. The evolution of myrmecophytism enabled *Macaranga* to radiate into enemy-free space, while the ants' diversification has been shaped by stem traits, host specialization, and geographic factors. We discuss the possibility that the ancient and exclusive association between *Decacrema* and *Macaranga* was facilitated by an impoverished diversity of myrmecophytes and phytoecious (obligately plant inhabiting) ants in the region.

Key words.—Coevolution, cospeciation, *Decacrema*, *Macaranga*, myrmecophyte, phytoecy, Southeast Asia.

Received June 17, 2003. Accepted October 13, 2003.

The species diversities of many plant-insect interactions ranging from mutualistic to antagonistic can be traced to ancient and continuous histories of coevolution, dating as far back as 200 million years (Ehrlich and Raven 1964; Farrell 1998; see also Labandeira et al. 1994; Pellmyr and Leebens-Mack 1999; Machado et al. 2001). In some cases, coevolution has even produced (approximately) matching phylogenies between insects and their host plants. Cospeciation, indicated by phylogenetic concordance (even if partial) between insects and their host plants, has been documented in antagonistic interactions coevolving via Ehrlich and Raven's (1964) model of "escape and radiation" (sensu Thompson 1989; e.g., butterflies, Brown 1981; beetles, Farrell and Mitter 1990, 1998). In mutualistic insect-plant associations, cospeciation has also been demonstrated in plants and their pollinating seed predators (e.g., Weiblen and Bush 2002). Another significant component of mutualistic interactions between plants and insects occurs mainly in the tropics and involves the protection of plants by ants, usually in return for housing and sometimes food. Phylogenetic studies of obligate ant and plant associates (e.g., Ward 1991, 1993, 1999; Ayala et al. 1996; Chenuil and McKey 1996) reveal the frequent occur-

rence of host shifts and de novo colonizations. Even the specificity of partnerships varies within and across both sides of ant-plant systems (Davidson and McKey 1993). These findings suggest that the dominant route to the species diversities of most ant-plant systems has involved associations between preadapted partners having no history of coevolution, as opposed to associations derived from cladogenesis in ancestral interactions.

The evolution of reproductive coupling in pollinating mutualisms (e.g., between figs and fig-wasps) reinforced pairwise specificity between symbionts (but see Molbo et al. 2003), facilitating the possibility of cospeciation via coevolution (Schemske 1983). In ant-plant mutualisms, intense competition for hosts (Fiala and Maschwitz 1990; Yu and Davidson 1997; Feldhaar et al. 2000) and uncoupled reproduction and dispersal of ant and plant associates may hinder the development of specificity. Nevertheless, associations comprising single-species partners are common and may be the result of pairwise coevolution (sensu Schemske 1983) molding facultative interactions into obligate associations (e.g., Brouat et al. 2001). However, considering the high frequency with which new associations are forged between

ants and plants (Janzen 1974; Longino 1989; Ward 1991, 1993, 1999; Ayala et al. 1996; Yu and Davidson 1997; Alvarez et al. 2001), coevolution need not result in cospeciation (see Janzen 1966; Thompson 1989).

We investigate the case for cospeciation (Itino et al. 2001) in a Southeast Asian ant-plant mutualism involving *Macaranga* trees and their highly specific *Crematogaster* (*Decacrema*) ants (hereafter referred to as *Decacrema*). In contrast to the conclusions of Itino et al. (2001), a phylogenetic study of host colonization patterns in *Decacrema* by Feldhaar et al. (2003) found an absence of cospeciation and a predominance of host switching. To elucidate the evolutionary history of this mutualism, we use nucleotide sequences from the mitochondrial gene cytochrome oxidase I (COI) for parsimony and Bayesian likelihood inference of the phylogeny of host use in the ants. We expand on the study by Itino et al. (2001) by sampling a greater geographic range and more host species, using more nucleotide characters for the phylogenetic analyses, and examining the phylogenesis of the ants' association with particular stem traits of *Macaranga* that may be implicated in the evolution of host use, thereby addressing some of the mechanistic bases for the observed patterns of host association. Using a published phylogeny of myrmecophytic *Macaranga* (Davies 2001a; Davies et al. 2001), we address the question of whether *Macaranga* and their *Decacrema* inhabitants show parallel cladogenesis. However, demonstrating cospeciation also requires overlapping time frames for the radiation of both lineages. We estimate the age of the *Macaranga*-associated *Decacrema* using rates of COI divergence estimated for other arthropod groups, and we infer the maximum age of myrmecophytic *Macaranga* based on their association with everwet forest in Southeast Asia (see Morley 2000).

The term "myrmecophyte" has been in use for several decades; however, a similar term for the other half of the association has been lacking. In this paper we introduce the term "phytoecy" to denote the obligate lifelong inhabitation of live plant cavities.

Natural History of the Macaranga-Decacrema Mutualism

Southeast Asia's answer to the tremendous radiation of myrmecophytes in the Neotropical *Cecropia* can be found in the ecologically analogous *Macaranga*, whose 29 myrmecophytic species constitute an important component of successional forests in the wet aseasonal zone of western Malesia (Sumatra, the Malay Peninsula, and Borneo) to which their distribution is restricted. A thorough description of this system can be found in Fiala et al. (1999). The bulk of myrmecophytic species occurs in two clades: the *Pachystemon* group (21 species) and the *Pruinosae* group (five species). Although closely related, these two clades represent separate origins of myrmecophytism (Blattner et al. 2001; Davies et al. 2001) based on two observations: (1) intervening taxa are nonmyrmecophytic (S. Davies, unpubl. data); and (2) traits related to ant association have different origins in each clade: in *Pachystemon*, food-bodies harvested by the ants are presented mostly on enclosed abaxial stipule surfaces, and hollow stem domatia are formed through natural pith degeneration; in *Pruinosae*, food-bodies are presented on exposed

adaxial stipule surfaces, and stem domatia must be hollowed out by the ants through pith removal (see fig. 7C, D in Davies et al. 2001). The ants defend their hosts against herbivores, vine infestation, and possibly fungal pathogens (Fiala et al. 1989; Heil et al. 1999; Itioka et al. 2000; Itino and Itioka 2001). They also gain supplemental nutrition from the exudates of *Coccus* scale insects tended within the hollow stems (Heckroth et al. 1998). Throughout western Malesia, all but one species in these two groups are inhabited by *Decacrema* ants (Fiala et al. 1999).

While the female castes of all other species of *Crematogaster* have 11 antennal segments, those of the *Decacrema* subgroup have 10 (or rarely nine; P. Ward, pers. comm.). *Decacrema* have been recorded only from Southeast Asia (Malaya, Sumatra, Borneo, Sulawesi, southern Philippines, New Guinea), Taiwan, Africa, and Madagascar (Bequaert 1922; Bolton 1995; Maschwitz and Fiala 1995; Fiala et al. 1999). The names *Crematogaster borneensis* André (1896), *C. decamera* Forel (1910), and *C. captiosa* Forel (1911) have been applied to the *Macaranga* inhabitants in Southeast Asia (e.g., Bequaert 1922; Fiala et al. 1989; Itino et al. 2001; Feldhaar et al. 2003). In Borneo, Malaya, and Sumatra, *Decacrema* are known only as inhabitants of *Macaranga* (Yamane 1997; Fiala et al. 1999; S. Yamane, pers. comm.). The *Decacrema* associated with *Macaranga* have been grouped into eight queen-based morphospecies with varying degrees of host specificity by Fiala et al. (1999). A recently published mtDNA phylogeny of this group indicates only partial gross-level congruence between mtDNA lineages and morphospecies (Feldhaar et al. 2003). The monophyly of *Decacrema* or of the *Macaranga* inhabitants is thus far uncertain.

Possible Role of Stem Traits in Host Use

An important distinction between the *Macaranga-Decacrema* mutualism and other radiations of ant-plant mutualisms is the highly specific association between the two groups (Fiala et al. 1999; S. Davies, pers. obs.). One mechanism proposed to maintain specificity between *Macaranga* and *Decacrema* is the epicuticular wax blooms coating the stems of some *Macaranga* species, which have been shown to pose a barrier to colonization by non-*Macaranga* ants (Federle et al. 1997). Nonwaxy species generally have smooth stems, although a few are pubescent. A second factor that may mediate host use by *Decacrema* are the different types of myrmecophytism found in the two groups of *Macaranga* as previously described (naturally hollow stem domatia and abaxial stipular food-body presentation in *Pachystemon* versus ant-excavated stem domatia and adaxial stipular food-body presentation in *Pruinosae*). Of the myrmecophytic traits that differ between *Pachystemon* and *Pruinosae* species, domatium type is most likely to mediate host use because founding queens on *Pruinosae* species must expend more time and energy in excavating domatia prior to colony establishment, and domatia must be continually excavated by workers as the host grows.

MATERIALS AND METHODS

Sampling

The cryptic nature of species limits in the ants warranted an extensive sampling regime. Including samples from Itino

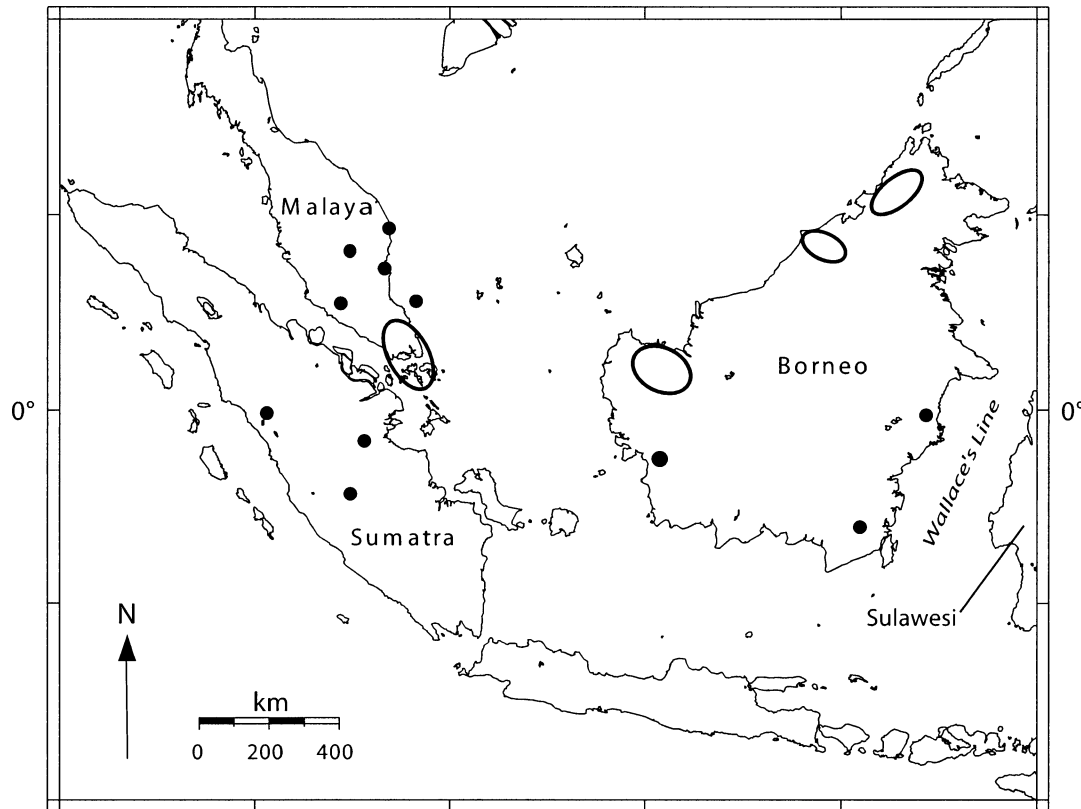

FIG. 1. Sampling locations for *Decacrema* collected from *Macaranga* in western Malasia, shown in dots and circles.

et al. (2001), *Decacrema* ants from 262 trees representing 22 *Macaranga* species (of 25 known to be associated with *Decacrema*) were collected throughout Borneo, Sumatra, and Malaya (Fig. 1), spanning most of the entire distribution of myrmecophytic *Macaranga*. One colony per *Macaranga* plant was assumed (but see Feldhaar et al. 2000). We concentrated on areas of high *Macaranga* species diversity, collected from multiple individuals of all host species present in a given area and sought to maximize the geographic spread of our sampling where possible.

To assess the monophyly of the *Decacrema* associates of *Macaranga*, we sampled a number of *Crematogaster* taxa, including: (1) phytoecious *Decacrema* from Sulawesi that inhabit stem domatia of *Neonauclea* (Rubiaceae; Maschwitz and Fiala 1995); (2) free-living *Decacrema* from Madagascar and Africa; (3) *Crematogaster* (non-*Decacrema*) from *Macaranga winkleri*, a myrmecophytic species not closely related to the *Pachystemon* and *Pruinosae* groups; (4) several *Crematogaster* (non-*Decacrema*) colonies that were found in a few individuals of the *Macaranga* species represented in this study; and (5) *C. dentinodis* and *C. minutissima*, from North America. The only known phytoecious *Decacrema* not included in our study are inhabitants of *Neonauclea* in southern Philippines (recorded in Bequaert 1922). Records of *Decacrema* from the Afro-Malagasy region suggest a nonphytoecious habit there, though often associated with plants and/or homopterans (S. P. Quek pers. obs.; see also <http://research.amnh.org/entomology/socialInsects/ants/westafrika/>

crem3.htm). We were unable to obtain *Decacrema* from Taiwan and New Guinea.

Although the monophyly of *Crematogaster* is well accepted, its internal phylogeny is unknown (Longino 2003); therefore, the rooting of any phylogeny within *Crematogaster* should be sought from outside *Crematogaster*, but within the Myrmecinae. We used a *Myrmecina* species to root our phylogenetic analyses. A sister taxon to *Crematogaster* has not been identified (B. Bolton, S. Cover, and P. Ward, pers. comm.).

In total, 281 *Crematogaster* samples are used in this study. All ants were collected in 70–100% ethanol, and voucher specimens, as well as host plant vouchers, have been deposited at Harvard's Museum of Comparative Zoology and Harvard University Herbaria, respectively, except for those used in Itino et al. (2001). Collection localities, host species and GenBank accession numbers associated with the samples are presented online in the Appendix at: <http://dx.doi.org/10.1554/03-361.1.S1>.

DNA Isolation, Polymerase Chain Reaction, and Sequencing

A 565-bp fragment of COI corresponding to positions 1683 to 2247 in the *Drosophila yakuba* mitochondrial genome (Clary and Wolstenholme 1985) was used for phylogenetic analyses. DNA was extracted from one to three ethanol-preserved ants per sample using a Chelex protocol modified from Walsh et al. (1991). The primers CI-13 (5'-ATA ATT TTT

TTT ATA GTT ATA CC-3') and CI-14 (5'-GTT TCT TTT TTT CCT CTT TC-3'), designed by E. Hasegawa (unpubl.), were used for polymerase chain reaction (PCR). The primers' 3' ends correspond to positions 2002+ (CI-13) and 2568- (CI-14) in the mitochondrial DNA sequence of *Apis mellifera* (Crozier and Crozier 1993). PCR consisted of 40 cycles of denaturing at 94°C for 30 sec, annealing at 48.5°C for 30 sec, and extension at 72°C for 40 sec and resulted in an amplification product of 608 bp. This was sequenced in both directions (Big Dye Terminator cycle sequencing, electrophoresis on ABI 377 and ABI 3100, Applied Biosystems, Foster City, CA). Sequences were compiled and edited with Sequencher 4.1 (Gene Codes Corporation, Ann Arbor, MI). For phylogenetic analyses, the primer sequences were removed, resulting in a consensus length of 565 bp. COI sequences were obtained from Itino et al. (2001) and included in this study. Although the sequences used in their previous study were trimmed to 496 bp, full untrimmed sequences were obtained for this study.

Phylogenetic Analyses

Of the 282 samples used in this study, 156 represent unique haplotypes and these alone were used in parsimony and Bayesian likelihood phylogenetic analyses. The degree of saturation due to multiple substitutions in the third codon position was assessed by plotting transition/transversion ratio (ti/tv) for third positions against total distance. The expected saturation level for ti/tv was determined by base composition following Holmquist (1983). An incongruence length difference test (Farris et al. 1994) was conducted to determine the presence of conflicts in phylogenetic signal between first and second codon positions versus third codon positions. For this test, implemented as the partition homogeneity test in PAUP* 4.0b10 (Swofford 1999), a heuristic search with 100 addition replicates revealed no conflict ($P > 0.5$). Thus, we combined all positions for parsimony and Bayesian likelihood phylogenetic analyses.

Most parsimonious (MP) trees were sought heuristically using PAUP* 4.0b10 (Swofford 1999), employing 1000 random addition replicates and TBR branch swapping, and clade support was assessed from 1000 bootstrap replicates using 10 random addition replicates. Bremer support (Bremer 1994) for nodes was assessed in Autodecay 4.0.2 (Eriksson 2001) using 100 random addition replicates in PAUP*.

Modeltest 3.06 (Posada and Crandall 1998) was used for hierarchical likelihood ratio tests for significant differences among increasingly complex substitution models, based on the program's neighbour-joining tree. The simplest substitution model not rejected by Modeltest was TVM + I + Γ , while the GTR + I + Γ model was selected by the Akaike information criterion (Akaike 1974). The large number of taxa in this study necessitated the use of MrBayes (Huelsenbeck and Ronquist 2000) for likelihood analyses, but because TVM models could not be implemented MrBayes 2.0, the GTR + I + Γ model was used. Three Bayesian likelihood (BL) analyses of the data were conducted in MrBayes 2.0 using Metropolis-coupled Markov chain Monte Carlo sampling at temperatures of 0.2, 0.8, and 1.5 and uninformative priors. In each analysis, four chains were run for 1×10^6

generations, each chain sampled every 100 generations. Trees with preasymptotic likelihood scores were removed, and the remaining trees were used to compute the majority rule consensus topology and posterior probabilities (Larget and Simon 1999). BL and MP trees were rooted with *Myrmecina*.

Analysis of Host Association Patterns

Stem traits

To assess whether the observed distribution of stem texture and domatium type was significantly different from that of a randomized distribution on the ant phylogeny, a permutation test was implemented with the PTP utility in PAUP* for each character following Kelley and Farrell (1998). This implementation of the PTP test produces a frequency distribution of tree lengths of the randomly permuted character on the ant topology and tests whether the observed tree length is significantly shorter than those produced under randomization. Each character was randomized 1000 times across the MP and BL topologies. Domatium type and stem texture were scored in MacClade 4.0 (Maddison and Maddison 1992) as naturally hollow or ant-excavated and as waxy or smooth (referring to all nonwaxy species), respectively. Waxy stems can be naturally hollow (*Pachystemon*) or ant-excavated (all *Pruinosae* species are waxy except for *M. puberula*). Therefore, the PTP test of stem texture was performed with and without the *Pruinosae* inhabitants.

Host preference

To determine if each ant clade was preferentially inhabiting or avoiding a particular host taxon or host type relative to that host's abundance, we conducted a one-way chi-square test in which the proportion of that host type/taxon among the ant clade's total hosts was compared to that host's sampled abundance as a proportion of all the sampled hosts available to the ant clade (i.e., wherever the ant clade was sampled; hosts observed in the field but not sampled were not included). For example, in testing the preference of ant clade A for waxy stems, the frequency of waxy stems in all the locations where A was collected was determined by counting their numbers as a proportion of the total number of sampled hosts in all of those locations. This gives the null expectation, that is, the proportion in which waxy stems should be found among the hosts of ant clade A, if host association is random. Five thousand Monte Carlo simulations of the sampling distribution were also performed to determine the extent of departure of the observed sample from the null distribution.

Phylogenetic congruence

To test for phylogenetic congruence between *Decacrema* and *Macaranga*, we employed two methods: a maximum codivergence approach to tree reconciliation (Page 1994a) implemented in TreeMap1.0 (Page 1994b) and a permutation procedure implemented in Parafit (Legendre et al. 2002), which tests for phylogenetic congruence in the observed associations between host and symbiont against the null hypothesis of random association. TreeMap reconciles host and symbiont phylogenies by maximizing the number of cospeciation events. To incorporate host switching, the exact

search option was used. By generating 1000 random ant trees in TreeMap (using the proportional-to-distinguishable option), the number of observed cospeciation events was tested against that obtained under randomization. Tree reconciliation ideally requires one-host/one-symbiont associations, however because several ant lineages were host generalists, a second analysis that is not sensitive to the presence of generalist host users was used. Parafit was employed following Legendre et al. (2002) and Desdevises et al. (2002). The program relies on three user-supplied matrices, two of which are principal coordinate representations of the host and symbiont phylogenies and one representing the individual links between branches in the host and symbiont phylogenies. From the three matrices, parafit computes a fourth-corner matrix (Legendre et al. 1997), which is used to test the hypothesis of cospeciation through a permutation procedure in which the matrix of links is randomized. The program implements a global test as well as tests of individual links between the host and symbiont phylogenies. A total of 999 permutations were performed in Parafit.

Congruence with the *Macaranga* phylogeny was tested in both the MP and BL ant topologies. The host *Macaranga* phylogeny used follows Davies (2001a), but with the recently derived clade of smooth *Pachystemon* species treated as a single taxonomic unit for analyses of cospeciation. This is because phylogenetic relationships among the species within this clade are poorly resolved, and ants appear unable to distinguish among the species within this clade—ant lineages that colonize the smooth *Pachystemon* clade tend to colonize most or all of the species whenever available (data not shown). Because *Pachystemon* and *Pruinosae* represent independent origins of myrmecophytism (Davies et al. 2001), congruence with the ant topology should be analyzed separately for the two groups. However, the ants appear unable to distinguish among the *Pruinosae* species also (data not shown). Therefore, only associations involving *Pachystemon* were used. The analyses were conducted (without *Pruinosae*) at different levels of host inclusion: all host taxa, and only host taxa making up the majority in their respective ant lineages. The exclusion of minority hosts reduces the complexity arising when every host species is included in the analyses and reduces noise that may mask signals of cospeciation. Additionally, TreeMap performs ideally under one host taxon per ant lineage; although dummy ant lineages can be created to accommodate multiple host taxa (as suggested by Page and Charleston 2002), their branching orders must be arbitrarily resolved if more than two host taxa are involved.

Biogeography and Age Estimation

Ancestral area reconstructions were traced on the BL *Decacrema* phylogeny in MacClade 4.0 (Maddison and Maddison 1992). Locations were scored as Borneo, Sumatra, or Malaya. Homogeneity of substitution rates across the average-branch-length consensus BL topology (see Fig. 3) was assessed using the likelihood ratio test (LRT, Huelsenbeck and Rannala 1997) as implemented in PAUP* 4.0b10. All duplicate haplotypes were removed for the LRT. The LRT employed the GTR + I + Γ model (I and Γ estimated and

empirical base frequencies used) with and without a molecular clock enforced, thus testing for significant deviations from the molecular clock. Because the LRT found significant deviations from rate constancy ($P < 0.001$), nonparametric rate smoothing (NPRS, Sanderson 1997), implemented in TreeEdit 1.0 (Rambaut and Charleston 2002), was used to homogenize evolutionary rates across the tree. Branch length variance was estimated using an approximation of a nonparametric procedure employed by Baldwin and Sanderson (1998; described in Davis et al. 2002).

We compiled a table of arthropod studies in which COI divergence rates had been calibrated using tenable independent evidence, such as well-established ages of habitats or geologic formations. Because those studies used different means of estimating COI divergences, it was desirable to standardize this measure; therefore, we obtained their reported COI sequences from GenBank and, using MEGA 2.1 (Kumar et al. 2001), we calculated the mean uncorrected pairwise distances for nodes that had been dated in the original study. We used the rates obtained to affix a date to a node in our rate-smoothed tree and used the resulting time frame to infer dates of other nodes. The dates for branching events representing geographic disjunctions in the *Decacrema* phylogeny were compared to dates inferred for the historical spread of several plant taxa in Southeast Asia (Morley 2000). These historical dispersal events may be representative of more widespread biotic dispersals in the region and may provide an independent assessment of our inferred time frame for *Decacrema*'s diversification in the region.

RESULTS

Phylogenetic Analyses

The plot of ti/tv in third positions against total distance (Fig. 2) shows an asymptotic approach within *Crematogaster*, suggesting transition saturation in third codon positions, even though the datapoints do not reach the expected saturation level calculated from base frequencies following Holmquist (1983; Fig. 2A). For Southeast Asian *Decacrema*, however, the graph does not appear to asymptote (Fig. 2B), suggesting negligible saturation in this group.

Three BL analyses were conducted at temperatures of 0.2, 0.8, and 1.5. After removal of trees with preasymptotic likelihood scores, 8200, 4840, and 6515 trees, respectively, remained; these were used to compute the majority rule consensus trees and posterior probabilities for each MrBayes run. The average-branch-length consensus tree of the analysis at sampling temperature 0.2 is shown in Figure 3. The topologies obtained from analyses at the other sampling temperatures converge with the topology in Figure 3, except that the *Decacrema* lineages C and D are swapped.

Because of transition saturation in third codon positions within *Crematogaster*, parsimony analysis was conducted with transitions in the third codon position downweighted by half. Of the 565 nucleotide characters, 255 are parsimony informative. The heuristic search yielded 16 MP trees of length 1806, consistency index 0.318, and retention index 0.815. Experimenting with unweighted parsimony produced no noteworthy differences from weighted parsimony in terms of topology and bootstrap support within *Decacrema*.

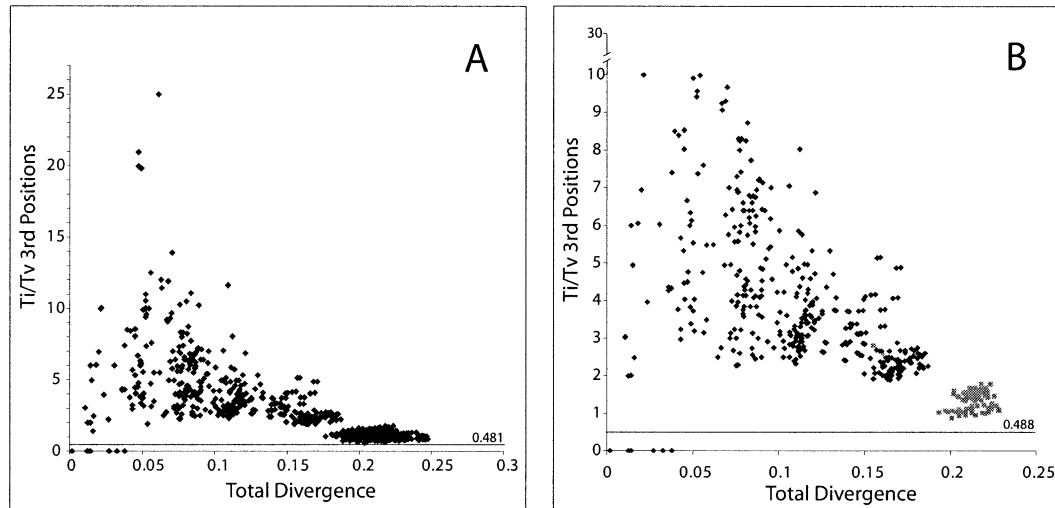

FIG. 2. Plot of transitions (ti) over transversions (tv) in third codon positions against uncorrected total divergence. The value of ti/tv expected at saturation (Holmquist 1983) is indicated. (A) *Crematogaster*; (B) Southeast Asian *Decacrema* (M + N); gray points show contrasts between the western Malesian *Decacrema* M and the Sulawesian *Decacrema* N, and black points show contrasts within *Decacrema* M.

Both analyses (Fig. 4) unanimously support the monophyly of the western Malesian *Macaranga*-inhabiting *Decacrema* (*Decacrema* M in Fig. 4), a sister relationship between *Decacrema* M and Sulawesian *Decacrema* in *Neonauclea* (*Decacrema* N), a sister relationship between Southeast Asian *Decacrema* (M + N) and Afro-Malagasy *Decacrema* (*Decacrema* P) and, therefore, the monophyly of *Decacrema*. Apart from the monophyly of *Decacrema* M, however, these findings should be regarded with some caution because support for the relationships outside this group is not high (Fig. 4).

From the 262 sequences within *Decacrema* M (Fig. 3), 11 and 10 well-supported lineages are identifiable in the MP and BL trees, respectively, designated A through K (Figs. 3, 5). These clades show considerable variation in size ($n = 2$ in clades B and E to $n = 89$ in clade H; Figs. 3, 6). Because our sampling was carried out with no a priori knowledge about ant distributions, the disparity in clade size probably reflects the natural abundance of the ant clades, but patchy sampling coupled with patchy ant and host distributions could also account for some of this variation. The monophyly of each of these lineages is well supported in both MP and BL topologies, with the exception of C whose monophyly is not found in the MP tree. Both trees also differ in the placement of lineages C, D, and E, whose positions are poorly supported in both topologies. These disagreements, however, do not present conflicting interpretations regarding the broad evolutionary patterns of host association.

Patterns of Host Association

Stem traits

The distribution of both stem texture and domatium type show distinct trends on the ant phylogeny (Fig. 6, Table 1). Basal ant lineages (A, B, C, D, E, and F) exclusively inhabit naturally hollow domatia while ant-excavated domatia are exclusively occupied by the younger lineages (G, K, J, and H), though these also occupy naturally hollow domatia.

Therefore, the association originated with *Pachystemon* species, and *Pruinosae* species were later added to the host range of *Decacrema*. In particular, waxy species of *Pachystemon* were colonized before the smooth-stemmed species. All three PTP tests (domatium type, stem texture with *Pruinosae* inhabitants, and stem texture without *Pruinosae* inhabitants) indicate that the stem traits are not randomly distributed on the *Decacrema* phylogeny ($P < 0.01$).

Host preference

Host preference was tested for clades of size $n \geq 5$; therefore, clades B, E, and J were not examined. As a conservative measure, for the more basal ant clades A–F, *Pruinosae* hosts were excluded from the pool of available hosts because, as shown in the analysis of association with stem traits (Fig. 6), this group of ants appears unable to colonize stems that require excavation (though the possibility that they are competitively excluded cannot be discounted). For the ant clades A, C, and D, which appear to be restricted to waxy *Pachystemon* hosts, the test was done for all *Pachystemon* species, as well as only waxy *Pachystemon* species counted as available hosts. The results of this analysis are presented in Table 2 and summarized in Figure 6. The *Decacrema* lineages that were examined show preference (or avoidance) for particular host taxa or stem types, except for lineage K, whose usage of hosts reflects their availability.

Phylogenetic congruence

Associations between *Macaranga* and *Decacrema* are shown in Figure 7. Parafit analysis (Table 3) indicates absence of congruence in the global tests for all levels of host inclusion. For tests in which only majority hosts were included, a few individual links were found to be significantly coevolutionary (see Table 3). Therefore, based on majority associations, Parafit analysis suggests only partial phylogenetic congruence between the ants and plants. Nearly identical results (not shown) were obtained with the MP topology.

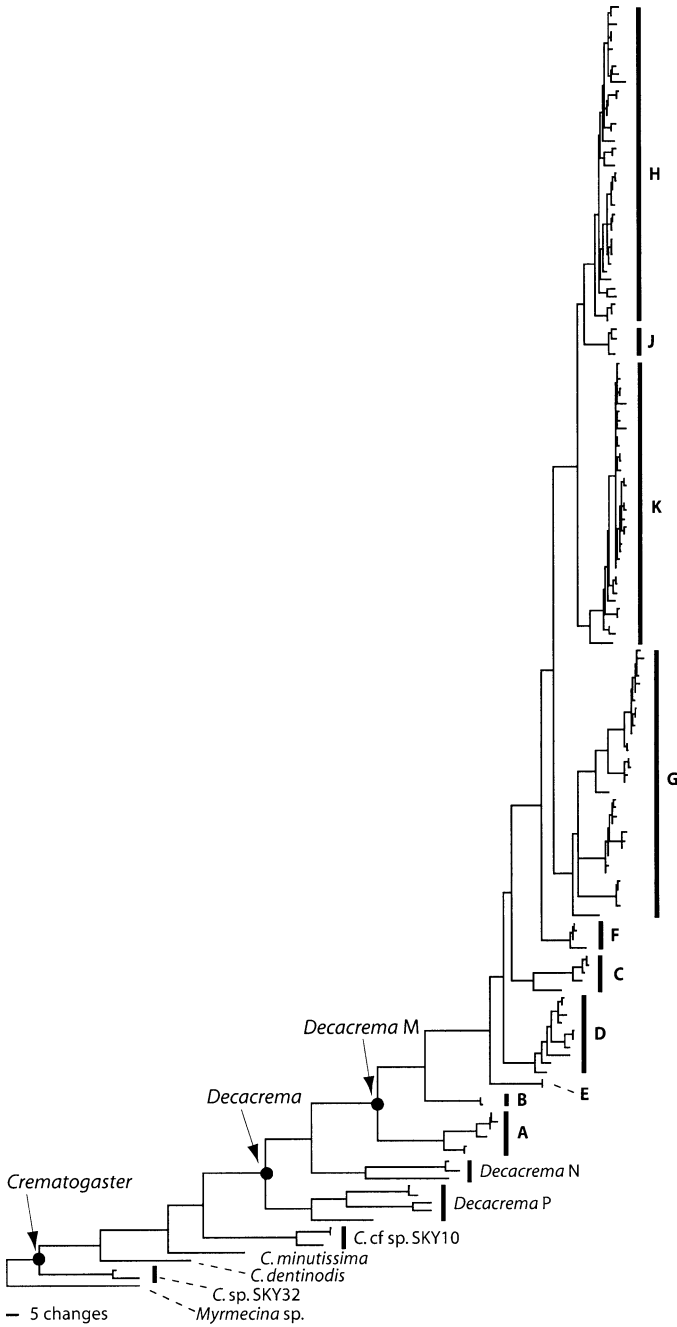

FIG. 3. Average-branch-length consensus of 8200 trees from Bayesian likelihood analysis at sampling temperature 0.2, rooted with *Myrmecina*. Names for clades below *Decacrema* are from published literature; all clade names within *Decacrema* are herein designated for the purposes of this study (see explanation of names in Fig. 4).

Based on the same three sets of associations as in ParaFit (Table 3), no cospeciation events were found in TreeMap. In an alternative analysis, we created dummy ant lineages to simulate one-to-one specificity between the ants and plants. In the cases where only hosts constituting $\geq 25\%$ and $\geq 22\%$ were used, several cospeciation events were obtained; however, they were reconstructed at the dummy ant nodes or between nodes that were not likely to have been contem-

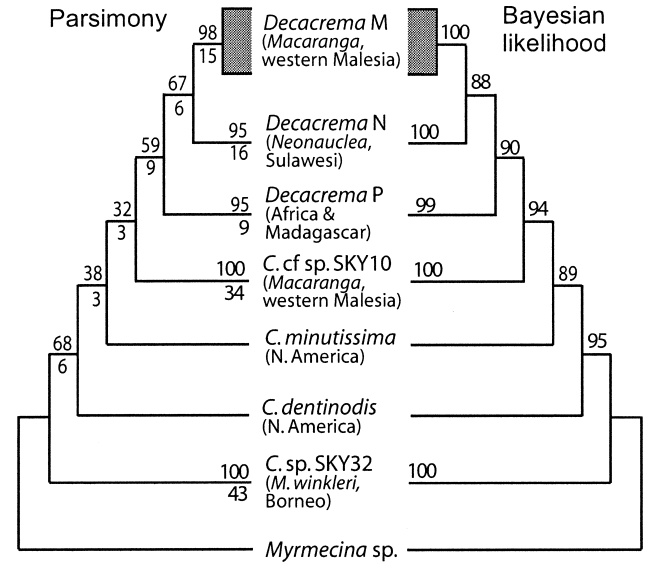

FIG. 4. Summary phylogeny of 281 *Crematogaster* samples plus one outgroup, showing monophyly of *Decacrema* inhabitants of *Macaranga* (*Decacrema* M). Left: strict consensus of 16 most parsimonious trees with bootstrap support above branches and decay indices below. Right: majority rule consensus of 8200 trees found by Bayesian likelihood analysis at sampling temperature 0.2 showing posterior probabilities above nodes. Analyses at the other sampling temperatures produced topologies identical to this with similar posterior probabilities. *Decacrema* M: *Macaranga* inhabitants from western Malesia (Borneo, Malaya, and Sumatra); *Decacrema* N: *Neonauclea* inhabitants from Sulawesi (east of western Malesia); *Decacrema* P: free-living ants from Madagascar and southern Africa; *C. cf. sp. SKY10* (Yamane 1997): non-*Decacrema* inhabitants of myrmecophytic *Macaranga*; *C. sp. SKY32* (S. Yamane, pers. comm. 2003): obligate non-*Decacrema* inhabitants of *M. winkleri* (cf. Msp. 8 in Fiala et al. 1999).

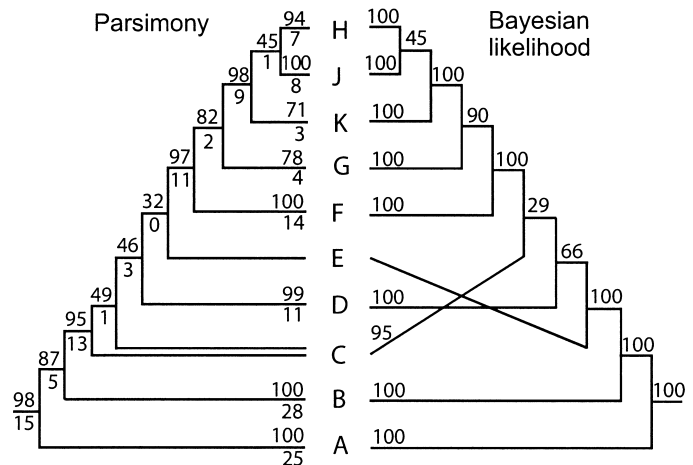

FIG. 5. Phylogenetic relationships within *Decacrema* M (*Macaranga* inhabitants in western Malesia), from parsimony (strict consensus of 16 trees) and Bayesian likelihood analyses. The Bayesian likelihood topology shown is from the analysis at sampling temperature 0.2. Bootstrap support (for parsimony) and posterior probabilities (for Bayesian likelihood) are shown above branches, and decay indices (parsimony) are below branches. Clade E comprises two identical sequences, one of which was removed for analyses, thus no branch support was provided in the analyses.

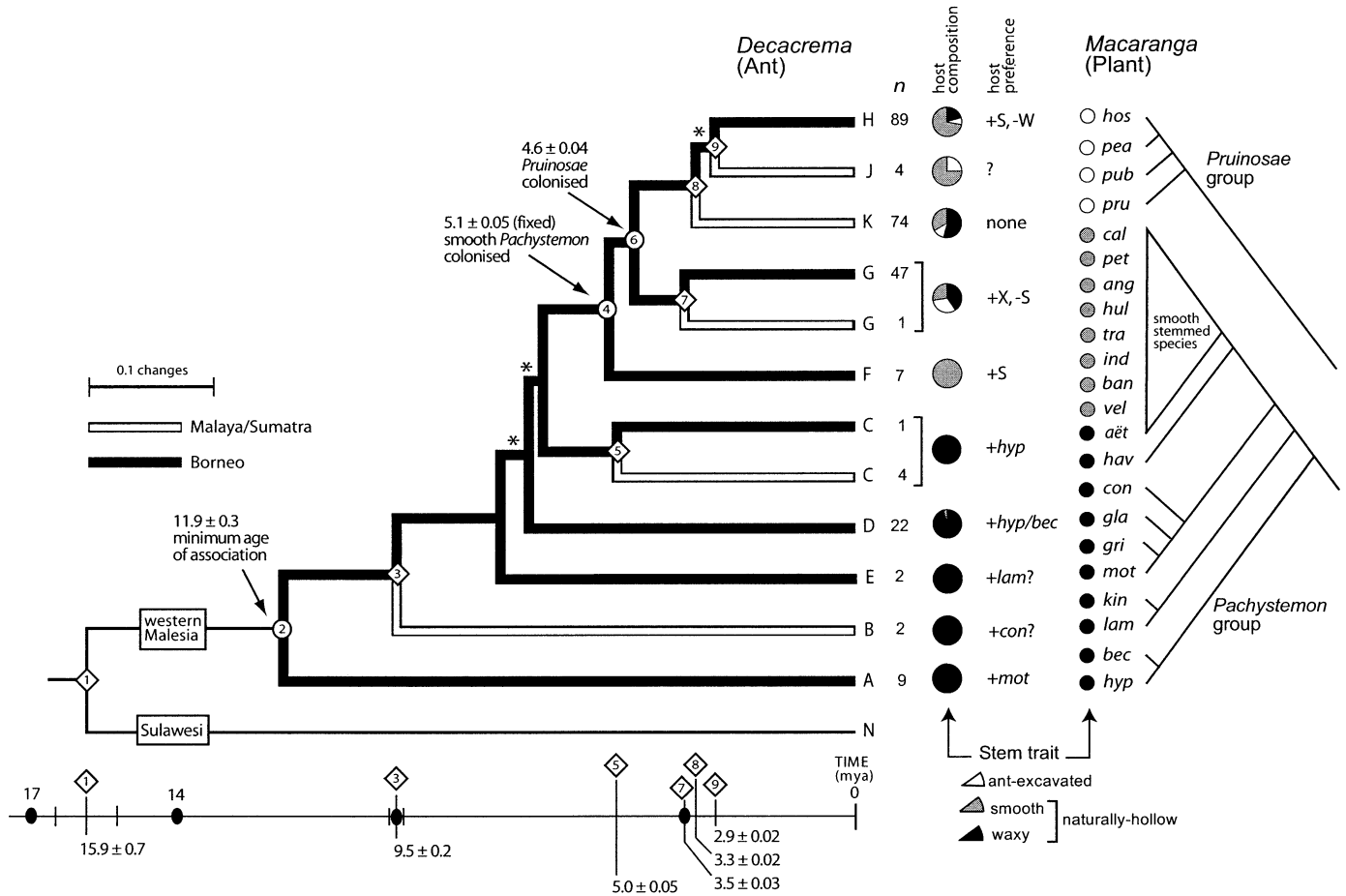

Fig. 6. Bayesian likelihood phylogeny of *Decacrema* COI lineages (left), showing geographic reconstruction (deltran resolution), sample size of lineages (*n*), host composition by stem type (pie charts, data from Table 1), and host preference (data from Table 2). Nodes with asterisks have posterior probabilities <70%; all other nodes are supported by posterior probabilities $\geq 88\%$. In the column denoting host preference, + indicates relative preference, - relative avoidance and ? insufficient sampling for statistical tests; S, smooth *Pachystemon* species; W, waxy *Pachystemon* species; X, ant-excavated species; for example, “-S” indicates avoidance of smooth *Pachystemon* species and “+hyp” indicates preference for *M. hypoleuca*. Distribution of stem types on the *Macaranga* phylogeny is shown (modified from Davies 2001a; Appendix (online) shows complete *Macaranga* names; except for *M. puberula*, all species in *Pruinosae* are also waxy). The *Decacrema* rate-smoothed chronogram is shown; nodes with circled numbers indicate key events and nodes with boxed numbers indicate geographic disjunctions. To calibrate the timeline, node 4 was fixed at 5.1 million years ago (see Materials and Methods). Black ovals on the timeline indicate dates of four biotic dispersal events posited to have occurred in the region based on fossil pollen from several taxa (Morley 2000). Nodes representing geographic splits in the phylogeny cluster around three of these events. Dates are given \pm variance (million years ago).

poraneous based on stem trait succession in the ant and plant phylogenies.

Biogeography and Age Estimation

Divergence rates for COI for the arthropod taxa we assembled from published literature ranged from 1.3% to 1.9% per million years (Table 4, calculated from uncorrected pairwise divergences). Within insects, the rate converged at about 1.5% per million years. Because these rates were typically obtained for divergences between 1.5% and 10%, we dated a well-supported node within *Decacrema* M within this divergence range and used it to calibrate a timeline for the rate-smoothed *Decacrema* chronogram. Node 4 in Figure 6 represents a 7.7% mean divergence between its descendent sister taxa that corresponds to an age of 5.1 ± 0.05 million years

using 1.5% per million years. The resulting minimum age of the *Decacrema* inhabiting *Macaranga* (node 2, Fig. 6) is 11.9 ± 0.3 million years.

Five clades (A, E, D, F, and H) are exclusively Bornean, three (B, J, and K) are exclusively Malayo-Sumatran, and C and G are each split into a Bornean and a non-Bornean lineage (Fig. 6). Reconstruction of ancestral distributions in MacClade suggests that Borneo was host to the major axis of diversification in the early history of *Decacrema*, and the Malayo-Sumatran assemblage represents relatively recent arrivals from Borneo, with the exception of lineage B (Fig. 6). Using deltran optimization in MacClade, nodes 1, 3, 5, 7, 8, and 9 (boxed numbers on timeline and tree, Fig. 6) represent geographic disjunctions. The dates calculated for all of these nodes, except node 5, fall very close to three of four dates

TABLE 1. Host composition of *Decacrema* lineages, by taxon and stem type. W, waxy *Pachystemon* species; S, smooth *Pachystemon* species; X, *Pruinosae* species (ant-excavated domatia). Note that all host species in the *Pruinosae* group are also waxy except for *Macaranga puberula*, which is host to one colony in lineage H and eight colonies in lineage G.

Ant lineage	Host taxon	Stem type	n	%	
A	<i>motleyana</i>	W	7	78	
	<i>hypoleuca</i>	W	2	22	
B	<i>constricta</i>	W	2	100	
C	<i>hypoleuca</i>	W	5	100	
D	<i>hypoleuca</i>	W	13	59	
	<i>beccariana</i>	W	5	23	
	<i>havilandii</i>	W	2	9	
	<i>motleyana</i>	W	1	4.5	
	<i>hullettii</i>	S	1	4.5	
E	<i>lamellata</i>	W	2	100	
F	smooth <i>Pachystemon</i>	S	7	100	
G (Borneo)	<i>motleyana</i>	W	12	26	
	<i>glandibracteolata</i>	W	4	9	
	<i>hypoleuca</i>	W	3	6	
	smooth <i>Pachystemon</i>	S	12	26	
	<i>Pruinosae</i> group	X	16	34	
G (Sumatra)	<i>hullettii</i>	S	1	100	
H	<i>hypoleuca</i>	W	8	9	
	<i>motleyana</i>	W	3	3	
	<i>glandibracteolata</i>	W	3	3	
	<i>lamellata</i>	W	1	1	
	smooth <i>Pachystemon</i>	S	67	75	
	<i>Pruinosae</i> group	X	7	8	
	J	smooth <i>Pachystemon</i>	S	3	75
	<i>Pruinosae</i> group	X	1	25	
K	<i>hypoleuca</i>	W	19	26	
	<i>griffithiana</i>	W	19	26	
	<i>kingii</i>	W	2	3	
	smooth <i>Pachystemon</i>	S	25	34	
	<i>Pruinosae</i> group	X	9	12	

inferred for mid-Miocene plant dispersals in the region based on palynological evidence. The four dates occur at 17 million years ago, 14 million years ago, 9.5 million years ago, and 3.5 million years ago (Morley 2000, p. 221). Node 1, straddling Wallace's line at 15.9 (± 0.7) million years ago, falls close to 17 million years ago; node 3 separating Malayan from an ancestrally Bornean sister, falls on 9.5 ± 0.2 million years ago; nodes 7, 8, and 9 cluster around 3.5 million years ago (see timeline, Fig. 6). Deltran optimization delays migrations out of Borneo and was favored because this ant-plant mutualism has very specific ecological requirements—warm perhumid climate and nutrient-rich environments (Davies 2001b); periods of low sea level (when the ants and plants could have ventured out of their Bornean cradle) would have coincided with a cool, dry climate (Morley 2000) unfavorable to the spread of rainforest taxa. Nevertheless, we also explored the most parsimonious resolving option in MacClade. In this case, the more recent geographic disjunctions are more ambiguous—the path through nodes 4, 6, 8, and 9 and between nodes 6 and 7 are equivocal. Therefore, any or all of nodes 4–9 are possible geographic splits; however, they still cluster approximately around 3.5 million years ago (5.1–2.9 million years ago). Area reconstructions for nodes 1, 3, and 5 are unchanged. The *Crematogaster* subgenus *Orthocrema* is represented in Dominican amber (Wilson

1988), thought to be 15–20 million years old (Iturralde-Vinent and MacPhee 1996). Our estimation for the divergence of the lineage leading to *C. minutissima*, a member of *Orthocrema*, is 22.8 ± 1.4 million years ago (data not shown) and predates the Dominican fossil by between 2.8 million years and 7.8 million years.

Ecogeographical Characteristics of *Decacrema* COI Lineages

Each lineage exhibits a unique combination of host preference and geographical distribution such that lineages that share similar host preferences can be differentiated by distribution (Table 5). For example, lineages A and B, preferential users of the closely related hosts *M. motleyana* and *M. constricta* (see host phylogeny in Fig. 6), respectively, are allopatric with A in Borneo and B in Malaya; lineages C and D, specialists on the *M. hypoleuca*–*beccariana* clade, are also geographically separated, with C mostly in Sumatra and D confined to Borneo; lineages F and H are partial toward the smooth *Pachystemon* clade, but F is endemic to a small region of northern Borneo while H is found throughout Borneo. G is the only lineage showing preference for *Pruinosae* hosts. Of the lineages J and K that are generalist host users, J is mostly Sumatran, whereas K is widespread and common in Malaya and Sumatra.

DISCUSSION

Although gene trees are not always expected to represent species phylogenies (Maddison 1997; Nichols 2001), mitochondrial DNA trees have proven robust in inferring species limits or corroborating morphological hypotheses in many studies (Moore 1995, 1997; Brower et al. 1996; Murphy et al. 1999; Rhocho-Olivares et al. 1999; Miura et al. 2000; Rand et al. 2000; Wiens and Penkrot 2002). However, as with the study by Feldhaar et al. (2003), an examination of the *Decacrema* queens in this study (~40 individuals) reveals only partial congruence between mitochondrial DNA lineages and morphospecies. Only a single morphospecies concurs with a mitochondrial DNA lineage in our tree (lineage A; S. Cover and S. Quek, unpubl. data). Morphology-based taxonomy of *Crematogaster* is notoriously difficult at the species level, with no certainty that morphological groupings reflect species. *Crematogaster* expert J. Longino (2003, p. 4) noted that it is “one of the intractable messes in the world of ant taxonomy” and “a group generally avoided by students of systematics seeking manageable projects.” In addition to intractable morphology, a possible explanation for the discordance between the COI tree and morphological groupings is that the former might be revealing higher level branching patterns but concealing more recent cryptic species with convergent morphologies (e.g., Joussetin et al. 2003; Molbo et al. 2003).

Conflict between gene trees and species (or population) trees can arise from gene introgression or incomplete lineage sorting (Avice 1994). Because the COI lineages in this study show geographic structuring (Bornean vs. extra-Bornean, as well as being spatially structured within Borneo; data not shown), incomplete lineage sorting is not likely to contribute significantly to the source of conflict, perhaps with the ex-

TABLE 2. One-way chi-square test for biased host association. W, waxy *Pachystemon* species; S, smooth *Pachystemon* species; X, *Pruinosae* species (ant-excavated domatia). *P*-values (nondirectional) are from 5000 Monte Carlo simulations. * $P \leq 0.05$; ** $P \leq 0.01$; *** $P \leq 0.001$; **** $P \leq 0.0001$; ns, not significant. The negative sign after the *P*-values indicates host avoidance, all other significant *P*-values indicate host preference.

Ant clade (sample size)	Host taxon/type tested	Available hosts	Expected proportion	Observed proportion	<i>P</i>
A (9)	<i>motleyana</i>	W + S	16/80 (0.20)	7/9 (0.78)	****
	<i>motleyana</i>	W	16/30 (0.53)	7/9 (0.78)	ns
	W	W + S	30/80 (0.34)	9/9 (1.0)	***
	X	W + S + X	9/90 (0.10)	0/9 (0.0)	ns
C (5)	<i>hypoleuca</i>	W + S	11/79 (0.14)	5/5 (1.0)	****
	<i>hypoleuca</i>	W	11/27 (0.41)	5/5 (1.0)	**
	W	W + S	27/79 (0.34)	5/5 (1.0)	**
	X	W + S + X	11/90 (0.12)	0/5 (0.0)	ns
D (22)	<i>hypoleuca</i> and <i>beccariana</i>	W + S	28/94 (0.30)	18/22 (0.82)	****
	<i>hypoleuca</i> and <i>beccariana</i>	W	28/49 (0.57)	18/21 (0.86)	*
	W	W + S	49/94 (0.52)	21/22 (0.95)	****
	X	W + S + X	10/104 (0.10)	0/22 (0.0)	ns
F (7)	S	W + S	13/26 (0.50)	7/7 (1.0)	*
	X	W + S + X	4/30 (0.13)	0/7 (0.0)	ns
	S	W + S + X	63/127 (0.50)	12/47 (0.26)	** (-)
G (47)	W	W + S + X	47/127 (0.37)	19/47 (0.40)	ns
	X	W + S + X	17/127 (0.13)	16/47 (0.34)	****
	S	W + S + X	84/170 (0.49)	64/89 (0.72)	****
H (89)	W	W + S + X	63/170 (0.37)	18/89 (0.20)	** (-)
	X	W + S + X	20/170 (0.12)	7/89 (0.08)	ns
	S	W + S + X	30/86 (0.35)	25/74 (0.34)	ns
K (74)	W	W + S + X	46/86 (0.53)	40/74 (0.54)	ns
	X	W + S + X	10/86 (0.12)	9/74 (0.12)	ns

ception of lineages J and K, which are both distributed across Malaya and Sumatra. Introgression of mitochondrial genomes across species boundaries has been documented (e.g., Ballard 2000; Sota and Vogler 2001; Shaw 2002; Wahlberg et al. 2003). Therefore, ideally, several independently segregating loci should be used to infer the phylogeny of *Decacrema* (Avisé 1994; Beltran et al. 2002). However, each mitochondrial DNA lineage in this study exhibits unique ecological and distributional traits that, in combination, distinguish it from other lineages: those lineages that share similar host preferences are differentiated by geographical distribution (Table 5). Although ecological and distributional traits alone may not definitively form the basis of a species concept, they are often the only information available to systematists in the absence of a robust morphological framework (or other means) for delimiting species. Each COI lineage is sympatric with other lineages (data not shown), yet distinct host preference or specialization is maintained, especially within Borneo. Although the possibility of mitochondrial DNA leakage across *Decacrema* species boundaries cannot be excluded, the maintenance of distinct ecological traits among the lineages of an intimate radiation such as this points to lineage cohesion in the face of gene flow. Nevertheless, the single-gene approach in this study warrants caution for inferences at lower taxonomic levels, particularly because morphological groupings are not upheld by the mitochondrial DNA tree, an occurrence also found in other ants (e.g., Parker and Rissing 2002; Savolainen and Vepsäläinen 2003). More importantly, our conclusions derive from a macroevolutionary perspective and should thus be robust to violations of species boundaries.

Evolution of Host Association

Codiversification

In contrast to the conclusions of Itino et al. (2001), the present study reveals an absence of overall phylogenetic congruence between *Decacrema* and *Macaranga*, though certain associations were deemed to be coevolutionary by Parafit, depending on the host taxa included. The more comprehensive sampling scheme used here has uncovered a few lineages undetected in the previous study (lineages A, B, C, and J) resulting in a change in topology, and it has added more host taxa to some of the *Decacrema* lineages from the previous study, thus altering our conclusions about the degree of host specificity of those lineages. In addition, this study shows that the association between *M. winkleri* and *C. sp. 32* (Fig. 4) that was included in the cospeciation analysis by Itino et al. (2001, fig. 1) is unrelated to that between *Decacrema* and their *Macaranga* hosts.

Despite the absence of overall phylogenetic congruence, the correlated succession of stem texture in the *Decacrema* and *Pachystemon* phylogenies posits a history of contemporaneous and associated diversification, or codiversification. The mutualism originated with waxy *Pachystemon* hosts, followed later by the colonization of smooth stems. Although the finer scale patterns of host association suggest that host shifts have been a significant process in the history of the mutualism (Fig. 7; see also Feldhaar et al. 2003), they have been constrained by the rule of Szidat (1940) such that ancient ants occur only on ancient hosts.

Experiments by Federle et al. (1997, 2000) suggest there are trade-offs between the ants' ability to walk on waxy ver-

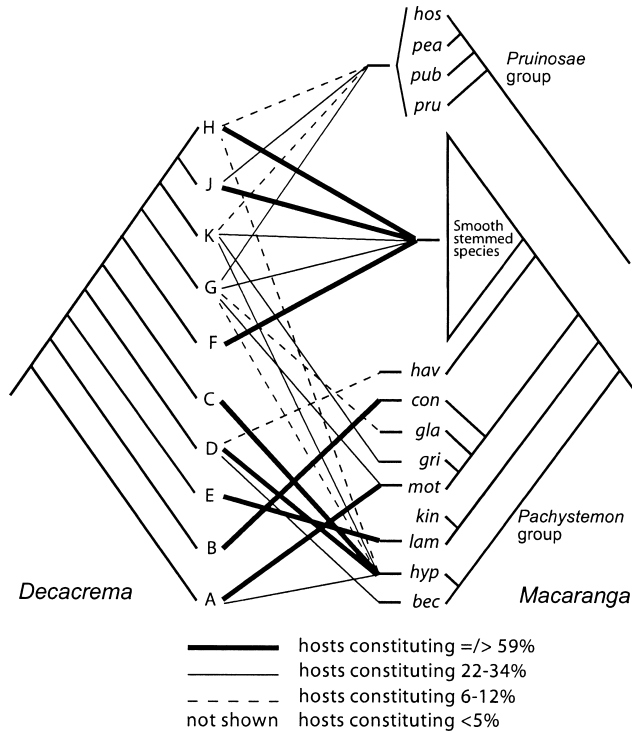

FIG. 7. Associations between *Decacrema* COI lineages (Bayesian likelihood topology, data from Table 1) and *Macaranga* species (phylogeny modified from Davies 2001a).

sus smooth stems. Inhabitants of waxy *Macaranga* were shown to walk more effectively on waxy stems when compared with those taken from smooth hosts and other ants not obligately associated with *Macaranga* (Federle et al. 1997). And when subjected to a strong centrifugal force, ants from smooth hosts maintained contact with smooth perspex significantly longer than those from waxy hosts (Federle et al. 2000). The hypothesized existence for trade-offs between walking ability on waxy versus smooth stems is also supported by patterns of host use in lineages confined to naturally hollow hosts—each specializes on waxy stems (lineages A, B, C, D, and E) or smooth stems (lineage F).

The greasy pole syndrome (Harley 1991) describes an effective mechanism independently derived in several plant lineages for preventing nectar robbery by ants via the production of copious wax coatings on stems. Likewise, Federle et al. (1997) have argued that waxy stems were favored as exclusion filters in the incipient evolution of *Macaranga* myrmecophytes. However, if wax is costly to the plant, its maintenance could be traded for other investments if its role as an exclusion filter could be replaced by ant behaviors that serve to deter intruders in the absence of the wax barrier. This is consistent with findings from two studies: (1) *Decacrema* from smooth stems pruned vegetation around their hosts significantly more than those from waxy stems (Federle et al. 2002; encroaching vegetation facilitates invasion by other ants); and (2) ants from *M. trachyphylla*, a species from the smooth *Pachystemon* clade, were more aggressive than ants from *M. beccariana*, a waxy *Pachystemon* species (Itioka et al. 2000). The origin of the smooth myrmecophytic species

TABLE 3. Results of ParaFit analysis of cocladogenesis using BL topology. *P*-values (from 999 randomizations) less than 0.05 indicate links showing significant cocladogenesis, denoted with an asterisk. The tests were done at three levels of host inclusion: (1) all hosts; and only hosts making up (2) ≥22%, and (3) ≥25% of the total hosts in a given ant clade. Note: because *Pruinosae* hosts were not included, the host proportions in a few ant clades do not add up to 100%.

Ant	Plant ¹	<i>P</i> (all hosts)	<i>P</i> (hosts ≥ 22%)	<i>P</i> (hosts ≥ 25%)
K	<i>griffithiana</i> (26%)	0.648	0.586	0.838
K	smooth <i>Pachystemon</i> (34%)	0.311	0.073	0.125
K	<i>hypoleuca</i> (26%)	0.965	0.993	0.806
K	<i>kingii</i> (3%)	0.546	—	—
H	smooth <i>Pachystemon</i> (75%)	0.268	0.048*	0.090
H	<i>motleyana</i> (3%)	0.617	—	—
H	<i>glandibracteolata</i> (3%)	0.519	—	—
H	<i>lamellata</i> (1%)	0.532	—	—
H	<i>hypoleuca</i> (9%)	0.958	—	—
J	smooth <i>Pachystemon</i> (75%)	0.284	0.056	0.095
G	<i>motleyana</i> (25%)	0.521	0.522	0.805
G	smooth <i>Pachystemon</i> (27%)	0.306	0.062	0.113
G	<i>glandibracteolata</i> (8%)	0.495	—	—
G	<i>hypoleuca</i> (6%)	0.958	—	—
F	smooth <i>Pachystemon</i> (100%)	0.262	0.117	0.203
C	<i>hypoleuca</i> (100%)	0.349	0.241	0.021*
D	<i>hypoleuca</i> (59%)	0.081	0.023*	0.028*
D	<i>beccariana</i> (23%)	0.080	0.023*	—
D	<i>motleyana</i> (5%)	0.954	—	—
D	<i>havilandii</i> (9%)	0.818	—	—
D	<i>hullettii</i> (5%)	0.633	—	—
E	<i>lamellata</i> (100%)	0.256	0.092	0.104
B	<i>constricta</i> (100%)	0.310	0.420	0.407
A	<i>motleyana</i> (78%)	0.844	0.840	0.545
A	<i>hypoleuca</i> (22%)	0.816	0.791	—
Global test		0.779	0.108	0.173

¹ Percentages in parentheses show proportion of ant samples in the given ant clade inhabiting the given host taxon.

TABLE 4. Cytochrome oxidase I (COI) rates for arthropod taxa calibrated independently and dated within 20 million years ago. The rates shown are from our calculations of mean uncorrected pairwise distances of dated nodes using downloaded GenBank sequences reported in the studies, with the exception of *Tetraopes* sequences whose reported distances were obtained in the same manner used in our study. The often-cited rate of 2.3% per million years by Brower (1994) was not included because the nucleotide fragment in that study contains only about 250 bp of COI, with COII comprising the majority. Therefore the Brower rate is more appropriate for COII which, early studies (e.g., Crozier and Crozier 1993) show, evolve faster than COI in *Apis* and *Drosophila*. In the Bathysciine study, two measures were used to derive dates, one based on all substitutions and another based on third-codon-position transversions. We used dates derived from the former to calculate COI rates because our measure also relies on all substitutions. Using this measure, we obtained two divergent rates: approximately 1.4% per million years for a younger set of divergences and 0.92% per million years for a node with 14.69% divergence dated to 16 million years ago. Because our distance measure is uncorrected, we report only the rate for the younger divergences, because the slower rate probably reflects some saturation at the deeper divergence.

Taxon	Distance (%)	Age (million years)	Rate (%/million years)	No. bp	Calibrated using age of
Bathysciine cave beetles ¹	8.89, 6.47	6.3, 4.5	1.41, 1.44	1406	Corsica-Sardinia plate separation
<i>Tetraopes</i> beetles ²	1.5–10.3	1–20	1.5 ⁶	1537	North American host habitat
<i>Maoricicada</i> ³	3.54	2.3	1.54	753	New Zealand alpine habitat
<i>Alpheus</i> mangrove shrimp ⁴	4.11	3	1.37	564	Panamanian isthmus formation
<i>Sesarma</i> land crabs ⁵	3.96, 5.88	3.1	1.28, 1.90	551	Panamanian isthmus formation

¹ Caccone and Sbordoni 2001.

² Farrell 2001.

³ Buckley et al. 2001.

⁴ Knowlton and Weigt 1998.

⁵ Schubart et al. 1998.

⁶ Based on regression line through five comparisons in the original study, with rates ranging from 0.5% to 3.1% per million years (see table 4 in Farrell 2001).

in the *Pachystemon* group may have been facilitated by such behavioral changes (greater pruning and aggressiveness) that replaced wax as the exclusion filter.

Horizontal transfer and the origin of myrmecophytes

The absence of *Pruinosae* associations in the early history of *Decacrema* points to the probable absence of *Pruinosae* myrmecophytes at that time. The phylogeny of host use (Fig. 6) suggests that *Pruinosae* species acquired their symbionts from *Pachystemon* myrmecophytes, consistent with the idea that myrmecophytism in *Pruinosae* and *Pachystemon* are not homologous (Davies et al. 2001). The colonization of *Pruinosae* appears to have disrupted a tendency for specialization in *Decacrema* (the earlier lineages A, B, C, D, E, and F appear to be characterised by host specialisation, Fig. 6). Rather than shifting, lineages G, H, J, and K expanded onto *Pruinosae* while retaining their *Pachystemon* hosts, thus becoming host generalists (Fig. 6).

While the patterns of association with *Pachystemon* suggest

host shifting, such shifts were occurring within the *Pachystemon* clade, that is, among taxa already adapted to harbor *Decacrema*. The expansion onto the novel *Pruinosae* hosts required new adaptations in *Decacrema*. Colonization of new host lineages can evolve as a result of competitive displacement (Jaenike 1990; see also Denno et al. 1995) when alternative hosts are readily available. Species of *Pachystemon* and *Pruinosae* are sympatric (Davies et al. 1998), and competition by ant foundresses for seedlings is intense (Fiala and Maschwitz 1990; Feldhaar et al. 2000). Under these conditions, selection would favor the exploration of novel host species such as those in *Pruinosae* with soft piths that might facilitate stem-excavating behavior.

The swollen-thorn acacias of Central America possibly represent another such scenario, where myrmecophytism in one species is thought to have been induced as a result of close proximity (spatially as well as phylogenetically) to a myrmecophytic species (Janzen 1974). The multiplicity of host taxa in many phytoecious ant taxa (earlier references)

TABLE 5. Host preference and geographic distribution of *Decacrema* lineages. Preference is defined as using a greater proportion of a host taxon than expected based on its availability relative to other host types (based on chi-square test results from Table 2). B, Borneo; M, Malaya; S, Sumatra.

Lineage	Host preference	Distribution
A	<i>M. motleyana</i>	B; widespread
B	<i>M. constricta</i> ¹	M; restricted
C	<i>M. hypoleuca</i>	B, M, mostly S; widespread
D	<i>M. hypoleuca</i> and <i>M. beccariana</i>	B; widespread
E	<i>M. lamellata</i> ¹	B, restricted
F	smooth <i>Pachystemon</i>	B; restricted
H	smooth <i>Pachystemon</i>	B; widespread
G	<i>Pruinosae</i> group	B ² ; widespread
J	none ¹	M, mostly S; widespread
K	none	M, S; widespread

¹ Not statistically tested due to small sample size.

² Contains one sample from Sumatra.

indicates that horizontal transfer in ant-plant mutualisms could be quite prevalent and could account for the origins of many myrmecophytic plant lineages.

Age and Biogeography

There are obviously error terms associated with the data in Table 4 (genetic distance measures and dates used as calibrations), thus the convergence in COI rates across disparate arthropod groups, and especially so across insects, is remarkable. Our results suggest that *Decacrema* colonized *Macaranga* at least 12 million years ago, in the mid-Miocene. By then, the Makassar Strait (part of Wallace's line separating Borneo from Sulawesi, see Fig. 1) already posed a formidable barrier to plant and animal dispersals. However, based on fossil pollen from several plant taxa, four biotic dispersal events across this line are posited to have occurred in the mid-Miocene, probably coinciding with periods of low standing sea level in the region (Morley 2000, p. 221). Our inferred dates for the geographic disjunctions in the *Decacrema* phylogeny are approximately contemporaneous with three of those dates (Fig. 6). Our divergence time estimates are also consistent with fossil evidence from Dominican amber (see *Biogeography and Age Estimation*). Thus, the true time frame for *Decacrema*'s diversification in Southeast Asia could well be reflected in our inferred timeline.

The precise distributional correlation of myrmecophytic *Macaranga* with the limits of aseasonal climate in western Malesia (Davies et al. 2001) suggests that they originated and diversified in a time and region of wet aseasonal climate supporting evergreen rainforests. The basic taxonomic composition of the present-day Southeast Asian rain forests can be traced to about 20 million years ago (early Miocene), when the predominantly subhumid or monsoonal vegetation of the Oligocene became replaced by evergreen vegetation, concomitant with the onset of a warm, perhumid climate (Morley 2000, p. 196). Myrmecophytic *Macaranga* are therefore not likely to be older than 20 million years, an age range that falls within the acceptable time frame for the mutualists to have sustained a long-term association. In addition, *Decacrema* lineages and *Macaranga* species share similar geographic patterns of distribution, diversity, and endemism both across the archipelago and within Borneo (Davies 2001a; S.P. Quek and T. Itino, unpubl. data). The independent lines of evidence we have presented from stem texture correlation and various aspects of historical biogeography all indicate that the evolutionary histories of *Decacrema* and *Pachystemon* have been contemporaneous and intertwined and that the mutualism likely originated at least 12 million years ago, in the mid-Miocene.

Although COI rates in the insect taxa in Table 4 converge on approximately 1.5% per million years, rate heterogeneity cannot be discounted. Therefore, we also calculate the age range based on the range of COI rates. Using 0.5–3.1% per million years (see Table 4), the minimum age of *Decacrema* M (node 2, Fig. 6) spans from about 36 million years to 6 million years. The age range extending into the more recent (~12 million years to 6 million years) is more credible because a pre-Miocene origin of *Decacrema* M is highly unlikely since *Macaranga* myrmecophytes are no older than the

Miocene, and substitution rate changes in *Decacrema* M are likely to be in the positive direction as several studies have shown accelerated rates for symbiotic lineages (e.g., Lutzoni and Pagel 1997; Miller and Crespi 2003).

Some of the errors associated with dating branching points (especially recent ones) stem from inadequate sampling over the geographic range of the taxa under study (Nichols 2001). Our sampling scheme necessarily covered a wide geographic range due to the lack of means to differentiate meaningful morphotypes. Therefore, the distribution of *Decacrema* lineages in this study probably reflects their natural geographic span, addressing the potential problem of dating errors associated with inadequate sampling. Moreover, the error in dating mitochondrial DNA divergences is not expected to be large compared with nuclear DNA divergences due to the small effective population size of mitochondrial loci (Moore 1995, 1997; Nichols 2001; but see Hoelzer 1997).

Codiversification in Ant-Plant Mutualisms

While coevolution has likely been the process that favored increased specialization in ant-plant interactions, subsequent speciation events of the associates have been to a large extent independent of each other, even though some or all lineages of the mutualists may remain associated (e.g., Ward 1993). Not surprisingly therefore, most myrmecophyte radiations worldwide have been shaped by habitat specialization, while the species diversity of their phytoecious ants has been influenced by competition leading to host or habitat specialization (Davidson and McKey 1993; Yu and Davidson 1997). This is likely a consequence of the asymmetric interdependence between myrmecophytes and their ants—the plants often represent almost the entire universe of resources required by the ants, whereas the ants constitute only a portion of the plants' resources, in addition to water, light, and nutrients. Thus, codiversification possibilities between obligately associated ants and plants may be influenced more by diversification of ants in response to myrmecophyte radiation, than by iterative reciprocal adaptation. The evolution of myrmecophytism enabled *Macaranga* to radiate into enemy-free space, while the ants' diversification has been shaped by stem traits, host specialization, and geographic factors (see *Ecogeographical Characteristics of Decacrema COI Lineages*).

Ancient histories have been demonstrated for associations between phytophagous insects and seed plants (since ~200 million years ago for chrysomeloid and curculionoid beetles and pre-angiosperm seed plants; Farrell 1998), between pollinating seed predators and angiosperms (40 million years ago for *Yucca* and yucca moths, Pellmyr and Leebens-Mack 1999; ~90 million years ago for figs and fig-wasps, Machado et al. 2001), and between insects and their cultivated fungi (~55 million years ago for attine ants, Mueller et al. 2001; 60–21 million years ago for weevils and ambrosia fungi, Farrell et al. 2001). This study has demonstrated the same ability for persistence through geologic time of ant-plant associations with their own set of interaction dynamics and specialized ecological requirements unique from that of other insect-plant interactions for which cospeciation has been demonstrated.

While the species diversity of most ant-plant systems has

resulted from de novo colonizations and host switching, what has enabled *Decacrema* and *Macaranga* to remain associated in the face of repeated speciation? Davidson and McKey (1993) hypothesized that the paucity of alternative myrmecophytic or phytoecious taxa within the territory of an ant-plant system may give associates sole priority over each other, allowing the mutualists to remain associated while undergoing speciation. Relative to tropical America, where the majority of known ant-plant systems are found, Southeast Asia appears impoverished of myrmecophytes and phytoecious ants (enumerated in Davidson and McKey 1993). Apart from *Macaranga*, the only substantial myrmecophyte radiation in Malesia occurs in *Neonauclea* (Rubiaceae) with more than 17 species (Ridsdale 1989). Thus, only two groups of species-rich myrmecophytes occur in Southeast Asia, and three ant genera containing substantial numbers of phytoecious ants occur in the same region: *Crematogaster* and *Camponotus*, both cosmopolitan in distribution, and *Cladomyrma*, an Asian endemic.

By contrast, substantial myrmecophyte diversity exists in nine plant genera in the Neotropics, six of which are endemic. Six ant genera with substantial species diversity of phytoecious ants are found in the Neotropics, four of which are endemic. *Macaranga* myrmecophytes in Malesia are regularly inhabited by only two ant genera. For example, although *Crematogaster* are the dominant colonizers of *Macaranga*, associations with the few myrmecophytic *Macaranga* species confined to nutrient-limited habitats such as swamp-forests and shaded forest understories are assumed mostly by one ant genus, *Camponotus* (Fiala et al. 1996; Maschwitz et al. 1996; Federle et al. 1998). By contrast, *Cecropia*, the neotropical analogues of *Macaranga*, are regularly inhabited by up to six ant genera (*Azteca*, *Allomerus*, *Camponotus*, *Crematogaster*, *Pachycondyla*, *Pseudomyrmex*; summarized in Davidson and McKey 1993). *Cecropia* myrmecophytes are also about twice as species-rich as their *Macaranga* counterparts. Although numerous biological, historical, and physical differences exist between tropical America and Southeast Asia, the significant disparity in genus- and species-level diversities of myrmecophytes and phytoecious ants between the two regions raises the possibility that guild diversity may be negatively correlated with the stability of specificity in associations between ants and plants over geologic time. Guild poverty in Southeast Asia may have presented the opportunity for long-term association between *Macaranga* and *Decacrema*.

Although many studies suggest the frequent occurrence of host shifts and de novo partnerships within mutualistic ant-plant systems (earlier references), comprehensive phylogenetic studies of both associates represent the exception rather than the rule (e.g., Chenuil and McKey 1996). More studies addressing the phylogenesis of such associations will clarify the extent of codiversification (or even cospeciation) in ant-plant mutualisms worldwide and will contribute toward building a broader understanding of the evolutionary dynamics that shape mutualistic interactions (Bronstein 1998).

ACKNOWLEDGMENTS

We thank A. Sequeira, B. O'Meara, M. Sanderson, B. Farrell, K. Abdul-Salim, and M. Schindlinger for analytical ad-

vice; P. Ward, G. Weiblen, R. Eastwood, C. Castillo-Davis, and two anonymous reviewers for comments on the manuscript; P. Wainwright for advice and discussion; P. Ashton for discussion on tropical rainforests and biogeographic history of Southeast Asia; S. Cover for morphological groupings of *Decacrema* queens and for the term *phytoecy*; G. Alpert for Malagasy samples; W. Federle for discussion on ant ambulation; S. Yamane for specimen identification; B. Fiala, H. Feldhaar, and J. Gadau for discussion and exchange of ideas; E. Hasegawa for COI primers, and A. Mignault and K. Ingram and D. Howarth for laboratory advice; W. Tantra, A. Langitan, A. Heath, A. Loo, D. Murphy, S. Pangkey, M. Frederickson, G. Lee, P. Todd, and J. Guest for assistance with fieldwork. This research was funded by National Science Foundation grants (DEB 9629601 to P. Ashton and DEB 0106866 to NEP and SPQ), and the following Harvard University funds: Putnam Expedition Grant (Museum of Comparative Zoology), and Department of Organismic and Evolutionary Biology Student Dissertation Grant. SJD thanks Sarawak Forest Department for permission to work in Sarawak, SPQ thanks Sabah Parks (Sabah, Malaysia) and National Parks Board (Singapore) for collecting permission. We thank S. K. Rambe for assistance in Indonesia.

LITERATURE CITED

- Akaike, H. 1974. A new look at the statistical model identification. *IEEE Trans. Autom. Contr.* 19:716–723.
- Alvarez, G., I. Armbrrecht, E. Jimenez, H. Armbrrecht, and P. Ulloa-Chacon. 2001. Ant-plant association in two *Tococa* species from a primary rain forest of Colombian Choco (Hymenoptera: Formicidae). *Sociobiology* 38:585–602.
- André, E. 1896. Fourmis nouvelles d'Asie et d'Australie. *Rev. Entomol.* 15:251–265.
- Avise, J. C. 1994. *Molecular markers, natural history and evolution.* Chapman and Hall, New York.
- Ayala, F. J., J. K. Wetterer, J. T. Longino, and D. L. Hartl. 1996. Molecular phylogeny of *Azteca* ants (Hymenoptera: Formicidae) and the colonization of *Cecropia* trees. *Mol. Phylogenet. Evol.* 5:423–428.
- Baldwin, B. G., and M. J. Sanderson. 1998. Age and rate diversification of the Hawaiian silversword alliance (Compositae). *Proc. Natl. Acad. Sci. USA* 95:9402–9406.
- Ballard, J. W. O. 2000. When one is not enough: introgression of mitochondrial DNA in *Drosophila*. *Mol. Biol. Evol.* 17:1126–1130.
- Beltran, M., C. D. Jiggins, V. Bull, M. Linares, J. Mallet, W. O. McMillan, and E. Bermingham. 2002. Phylogenetic discordance at the species boundary: comparative gene genealogies among rapidly radiating *Heliconius* butterflies. *Mol. Biol. Evol.* 19:2176–2190.
- Bequaert, J. 1922. Ants in their diverse relations to the plant world. *B. Am. Mus. Nat. Hist.* 45:333–584.
- Blattner, F. R., K. Weising, G. Banfer, U. Maschwitz, and B. Fiala. 2001. Molecular analysis of phylogenetic relationships among myrmecophytic *Macaranga* species (Euphorbiaceae). *Mol. Phylogenet. Evol.* 19:331–344.
- Bolton, B. 1995. *A new general catalogue of the ants of the world.* Harvard Univ. Press, Cambridge, MA.
- Bremer, K. 1994. Branch support and tree stability. *Cladistics* 10:295–304.
- Bronstein, J. L. 1998. The contribution of ant plant protection studies to our understanding of mutualism. *Biotropica* 30:150–161.
- Brouat, C., N. Garcia, C. Andary, and D. McKey. 2001. Plant lock and ant key: pairwise coevolution of an exclusion filter in an ant-plant mutualism. *Proc. R. Soc. Lond. B.* 268:2131–2141.
- Brower, A. V. Z. 1994. Rapid morphological radiation and convergence among races of the butterfly *Heliconius erato* inferred

- from patterns of mitochondrial DNA evolution. *Proc. Natl. Acad. Sci. USA*. 91:6491–6495.
- Brower, A. V. Z., R. DeSalle, and A. Vogler. 1996. Gene trees, species trees and systematics. *Annu. Rev. Ecol. Syst.* 27: 423–450.
- Brown, K. S. 1981. The biology of *Heliconius* and related genera. *Annu. Rev. Entomol.* 26:427–456.
- Buckley, T. R., C. Simon, and G. K. Chambers. 2001. Phylogeography of the New Zealand cicada *Maoricicada campbelli* based on mitochondrial DNA sequences: ancient clades associated with Cenozoic environmental change. *Evolution* 55:1395–1407.
- Caccone, A., and V. Sbordoni. 2001. Molecular biogeography of cave life: a study using mitochondrial DNA from Bathysciine beetles. *Evolution* 55:122–130.
- Chenuil, A., and D. B. McKey. 1996. Molecular phylogenetic study of a myrmecophyte symbiosis: Did *Leonardoxa*/ant associations diversify via cospeciation? *Mol. Phylogenet. Evol.* 6:270–286.
- Clary, D. O., and D. R. Wolstenholme. 1985. The mitochondrial DNA molecule of *Drosophila yakuba*: nucleotide sequence, gene organization, and genetic code. *J. Mol. Evol.* 22:252–271.
- Crozier, R. H., and Y. C. Crozier. 1993. The mitochondrial genome of the honeybee *Apis mellifera*: complete sequence and genome organization. *Genetics* 133:97–117.
- Davidson, D. W., and D. McKey. 1993. The evolutionary ecology of symbiotic ant-plant relationships. *J. Hym. Res.* 2:13–83.
- Davies, S. J. 2001a. Systematics of *Macaranga* sections *Pachystemon* and *Pruinosae* (Euphorbiaceae). *Harv. Pap. Bot.* 6: 371–448.
- . 2001b. Tree mortality and growth in 11 sympatric *Macaranga* species in Borneo. *Ecology* 82:920–932.
- Davies, S. J., P. A. Palmiotto, P. S. Ashton, H. S. Lee, and J. V. Lafrankie. 1998. Comparative ecology of 11 sympatric species of *Macaranga* in Borneo: tree distribution in relation to horizontal and vertical resource heterogeneity. *J. Ecol.* 86:662–673.
- Davies, S. J., S. K. Y. Lum, R. Chan, and L. K. Wang. 2001. Evolution of myrmecophytism in western Malaysian *Macaranga* (Euphorbiaceae). *Evolution* 55:1542–1559.
- Davis, C. C. D., C. D. Bell, P. W. Fritsch, and S. Mathews. 2002. Phylogeny of *Acridocarpus-Brachylophon* (Malpighiaceae): implications for Tertiary tropical floras and AfroAsian biogeography. *Evolution* 56:2395–2405.
- Denno, R. F., M. S. McClure, and J. R. Ott. 1995. Interspecific interactions in phytophagous insects: competition reexamined and resurrected. *Annu. Rev. Entomol.* 40:297–331.
- Desdèvises, Y., S. Morand, O. Jousson, and P. Legendre. 2002. Coevolution between *Lamellodiscus* (Monogenea: Diplectanidae) and Sparidae (Teleostei): the study of a complex host-parasite system. *Evolution* 56:2459–2471.
- Ehrlich, P. R., and P. H. Raven. 1964. Butterflies and plants: a study in coevolution. *Evolution* 18:586–608.
- Eriksson, T. 2001. Autodecay. Bergius Foundation of the Royal Swedish Academy of Sciences, Stockholm, Sweden.
- Farrell, B. D. 1998. ‘‘Inordinate fondness’’ explained: Why are there so many beetles? *Science* 281:555–559.
- . 2001. Evolutionary assembly of the milkweed fauna: cytochrome oxidase I and the age of *Tetraopes* beetles. *Mol. Phylogenet. Evol.* 18:467–478.
- Farrell, B., and C. Mitter. 1990. Phylogenesis of insect plant interactions: Have *Phyllobrotica* leaf beetles (Chrysomelidae) and the Lamiales diversified in parallel? *Evolution* 44:1389–1403.
- . 1998. The timing of insect/plant diversification: Might *Tetraopes* (Coleoptera: Cerambycidae) and *Asclepias* (Asclepiadaceae) have co-evolved? *Biol. J. Linn. Soc.* 63:553–577.
- Farrell, B. D., A. S. Sequeira, B. C. O’Meara, B. B. Normark, J. H. Chung, and B. H. Jordal. 2001. The evolution of agriculture in beetles (Curculionidae: Scolytinae and Platypodinae). *Evolution* 55:2011–2027.
- Farris, J. S., M. Källersjö, A. C. Kluge, and C. Bult. 1994. Testing significance of incongruence. *Cladistics* 10:315–319.
- Federle, W., U. Maschwitz, B. Fiala, M. Riederer, and B. Hölldobler. 1997. Slippery ant-plants and skillful climbers: selection and protection of specific ant partners by epicuticular wax blooms in *Macaranga* (Euphorbiaceae). *Oecologia* 112:217–224.
- Federle, W., B. Fiala, and U. Maschwitz. 1998. *Camponotus* (Colobopsis) (Mayr 1861) and *Macaranga* (Thouars 1806): a specific two-partner ant-plant system from Malaysia. *Trop. Zool.* 11: 83–94.
- Federle, W., K. Rohrseitz, and B. Hölldobler. 2000. Attachment forces of ants measured with a centrifuge: better ‘wax-runners’ have a poorer attachment to a smooth surface. *J. Exp. Biol.* 203: 505–512.
- Federle, W., U. Maschwitz, and B. Hölldobler. 2002. Pruning of host plant neighbours as defence against enemy ant invasions: *Crematogaster* ant partners of *Macaranga* protected by ‘wax barriers’ prune less than their congeners. *Oecologia* 132: 264–270.
- Feldhaar, H., B. Fiala, R. bin Hashim, and U. Maschwitz. 2000. Maintaining an ant-plant symbiosis: secondary polygyny in the *Macaranga triloba-Crematogaster* sp. association. *Naturwissenschaften* 87:408–411.
- Feldhaar, H., B. Fiala, J. Gadau, M. Mohamed, and U. Maschwitz. 2003. Molecular phylogeny of *Crematogaster* subgenus *Decacrema* ants (Hymenoptera: Formicidae) and the colonization of *Macaranga* (Euphorbiaceae) trees. *Mol. Phylogenet. Evol.* 27: 441–452.
- Fiala, B., and U. Maschwitz. 1990. Studies on the Southeast Asian ant-plant association *Crematogaster borneensis*/*Macaranga*: adaptations of the ant partner. *Insectes Soc.* 37:212–231.
- Fiala, B., U. Maschwitz, T. Y. Pong, and A. J. Helbig. 1989. Studies of a Southeast Asian ant-plant association: protection of *Macaranga* trees by *Crematogaster borneensis*. *Oecologia* 79: 463–470.
- Fiala, B., U. Maschwitz, and K. E. Linsenmair. 1996. *Macaranga caladiifolia*, a new type of ant-plant among Southeast Asian myrmecophytic *Macaranga* species. *Biotropica* 28:408–412.
- Fiala, B., A. Jakob, and U. Maschwitz. 1999. Diversity, evolutionary specialization and geographic distribution of a mutualistic ant-plant complex: *Macaranga* and *Crematogaster* in South East Asia. *Biol. J. Linn. Soc.* 66:305–331.
- Forel, A. 1910. Glanures myrmécologiques. *Ann. Soc. Entomol. Belg.* 54:6–32.
- . 1911. Fourmis de Bornéo, Singapore, Ceylan, etc. *Rev. Suisse Zool.* 19:23–62.
- Harley, R. 1991. The greasy pole syndrome. Pp. 430–433 in C. R. Huxley and D. F. Cutler, eds. *Ant-plant interactions*. Oxford Univ. Press, Oxford, U.K.
- Heckroth, H. P., B. Fiala, P. J. Gullan, A. H. Idris, and U. Maschwitz. 1998. The soft scale (Coccidae) associates of Malaysian ant-plants. *J. Trop. Ecol.* 14:427–443.
- Heil, M., B. Fiala, K. E. Linsenmair, and T. Boller. 1999. Reduced chitinase activities in ant plants of the genus *Macaranga*. *Naturwissenschaften* 86:146–149.
- Hoelzer, G. A. 1997. Inferring phylogenies from mtDNA variation: mitochondrial-gene trees versus nuclear-gene trees revisited. *Evolution* 51:622–626.
- Holmquist, R. 1983. Transitions and transversions in evolutionary descent: an approach to understanding. *J. Mol. Evol.* 19: 134–144.
- Huelsenbeck, J. P., and B. Rannala. 1997. Phylogenetic methods come of age: testing hypotheses in an evolutionary context. *Science* 276:227–232.
- Huelsenbeck, J. P., and F. Ronquist. 2000. MrBayes: Bayesian inference of phylogeny. Department of Biology, Univ. of Rochester, Rochester, NY.
- Itino, T., and T. Itioka. 2001. Interspecific variation and ontogenetic change in anti-herbivore defense in myrmecophytic *Macaranga* species. *Ecol. Res.* 16:765–774.
- Itino, T., S. J. Davies, H. Tada, Y. Hieda, M. Inoguchi, T. Itioka, S. Yamane, and T. Inoue. 2001. Cospeciation of ants and plants. *Ecol. Res.* 16:787–793.
- Itioka, T., M. Nomura, Y. Inui, T. Itino, and T. Inoue. 2000. Difference in intensity of ant defense among three species of *Macaranga* myrmecophytes in a Southeast Asian dipterocarp forest. *Biotropica* 32:318–326.
- Iturralde-Vinent, M. A., and R. D. E. MacPhee. 1996. Age and

- paleogeographical origin of Dominican amber. *Science* 273: 1850–1852.
- Jaenike, J. 1990. Host specialization in phytophagous insects. *Annu. Rev. Ecol. Syst.* 21:243–273.
- Janzen, D. H. 1966. Coevolution of mutualism between ants and acacias in Central America. *Evolution* 20:249–275.
- . 1974. Swollen-thorn acacias of Central America. *Smithson. Contrib. Bot.* 13:1–131.
- Jousselin, E., J. Y. Rasplus, and Kjellberg. 2003. Convergence and coevolution in a mutualism: evidence from a molecular phylogeny of *Ficus*. *Evolution* 57:1255–1269.
- Kelley, S. T., and B. D. Farrell. 1998. Is specialization a dead end? The phylogeny of host use in *Dendroctonus* bark beetles (Scolytidae). *Evolution* 52:1731–1743.
- Knowlton, N., and L. A. Weigt. 1998. New dates and new rates for divergence across the Isthmus of Panama. *Proc. R. Soc. Lond. B* 265:2257–2263.
- Kumar, S., K. Tamura, I. B. Jakobsen, and M. Nei. 2001. MEGA 2.1: molecular evolutionary genetics analysis software. *Bioinformatics* 17:1244–1245.
- Labandeira, C. C., D. L. Dilcher, D. R. Davis, and D. L. Wagner. 1994. Ninety-seven million years of angiosperm-insect association: paleobiological insights into the meaning of coevolution. *Proc. Natl. Acad. Sci. USA* 91:12278–12282.
- Larget, B., and D. Simon. 1999. Markov chain Monte Carlo algorithms for the Bayesian analysis of phylogenetic trees. *Mol. Biol. Evol.* 16:750–759.
- Legendre, P., R. Galzin, and M. L. Harmelin-Vivien. 1997. Relating behavior to habitat: solutions to the fourth-corner problem. *Ecology* 78:547–562.
- Legendre, P., Y. Desdevises, and E. Bazin. 2002. A statistical test for host-parasite coevolution. *Syst. Biol.* 51:217–234.
- Longino, J. T. 1989. Geographic variation and community structure in an ant-plant mutualism: *Azteca* and *Cecropia* in Costa Rica. *Biotropica* 21:126–132.
- . 2003. The *Crematogaster* (Hymenoptera, Formicidae, Myrmicinae) of Costa Rica. *Zootaxa* 151:1–150.
- Lutzoni, F., and M. Pagel. 1997. Accelerated evolution as a consequence of transitions to mutualism. *Proc. Natl. Acad. Sci. USA* 94:11422–11427.
- Machado, C. A., E. Jousselin, F. Kjellberg, S. G. Compton, and E. A. Herre. 2001. Phylogenetic relationships, historical biogeography and character evolution of fig-pollinating wasps. *Proc. R. Soc. Lond. B* 268:685–694.
- Maddison, W. P. 1997. Gene trees in species trees. *Syst. Biol.* 46: 523–536.
- Maddison, W. P., and D. R. Maddison. 1992. *MacClade: analysis of phylogeny and character evolution*. Sinauer Associates, Sunderland, MA.
- Maschwitz, U., and B. Fiala. 1995. Investigations on ant plant associations in the Southeast Asian genus *Neonauclea* Merr (Rubiaceae). *Acta Oecol.* 16:3–18.
- Maschwitz, U., B. Fiala, S. J. Davies, and L. E. Linsenmair. 1996. A Southeast Asian myrmecophyte with two alternative inhabitants: *Camponotus* or *Crematogaster* as partners of *M. lamellata*. *Ecotropica* 2:29–40.
- Miller, D. G., and B. Crespi. 2003. The evolution of inquilineism, host-plant use and mitochondrial substitution rates in *Tamalia* gall aphids. *J. Evol. Biol.* 16:731–743.
- Miura, T., Y. Roisin, and T. Matsumoto. 2000. Molecular phylogeny and biogeography of the nasute termite genus *Nasutitermes* (Isoptera: Termitidae) in the Pacific tropics. *Mol. Phylogenet. Evol.* 17:1–10.
- Molbo, D., C. A. Machado, J. G. Sevenster, L. Keller, and E. A. Herre. 2003. Cryptic species of fig-pollinating wasps: implications for the evolution of the fig-wasp mutualism, sex allocation, and precision of adaptation. *Proc. Natl. Acad. Sci. USA* 100: 5867–5872.
- Moore, W. S. 1995. Inferring phylogenies from mtDNA variation: mitochondrial-gene trees versus nuclear-gene trees. *Evolution* 49:718–726.
- . 1997. Mitochondrial-gene trees versus nuclear-gene trees, a reply to Hoelzer. *Evolution* 51:627–629.
- Morley, R. J. 2000. *Origin and evolution of tropical rain forests*. John Wiley and Sons, Chichester, U.K.
- Mueller, U. G., T. R. Schultz, C. R. Currie, R. M. M. Adams, and D. Malloch. 2001. The origin of the attine ant-fungus mutualism. *Q. Rev. Biol.* 76:169–197.
- Murphy, W. J., T. N. P. Nguyen, E. B. Taylor, and G. E. Collier. 1999. Mitochondrial DNA phylogeny of West African aplocheiloid killifishes (Cyprinodontiformes, Aplocheilidae). *Mol. Phylogenet. Evol.* 11:343–350.
- Nichols, R. 2001. Gene trees and species trees are not the same. *Trends Ecol. Evol.* 16:358–364.
- Page, R. D. M. 1994a. Maps between trees and cladistic analysis of historical associations among genes, organisms and areas. *Syst. Biol.* 42:58–77.
- . 1994b. *TreeMap 1.0*. Division of Environmental and Evolutionary Biology, Institute of Biomedical and Life Sciences, Univ. of Glasgow, Glasgow, U.K.
- Page, R. D. M., and M. A. Charleston. 2002. *TreeMap versus BPA (again): a response to Dowling*. Technical Reports in Taxonomy 02–02. Available via <http://taxonomy.zoology.gla.ac.uk/publications/tech-reports>.
- Parker, J. D., and S. W. Rissing. 2002. Molecular evidence for the origin of workerless social parasites in the ant genus *Pogonomyrmex*. *Evolution* 56:2017–2028.
- Pellmyr, O., and J. Leebens-Mack. 1999. Forty million years of mutualism: evidence for Eocene origin of the yucca-yucca moth association. *Proc. Natl. Acad. Sci. USA* 96:9178–9183.
- Posada, D., and K. A. Crandall. 1998. Modeltest: testing the model of DNA substitutions. *Bioinformatics* 14:817–818.
- Rambaut, A., and M. Charleston. 2002. *TreeEdit 1.0 alpha 10: phylogenetic tree editor*. Dept. of Zoology, Univ. of Oxford, Oxford, U.K.
- Rand, D. B., A. Heath, T. Suderman, and N. E. Pierce. 2000. Phylogeny and life history evolution of the genus *Chrysoritis* within the Aphnaeini (Lepidoptera: Lycaenidae), inferred from mitochondrial cytochrome oxidase I sequences. *Mol. Phylogenet. Evol.* 17:85–96.
- Ridsdale, C. E. 1989. A revision of *Neonauclea* (Rubiaceae). *Blumea* 34:177–275.
- Rocha-Olivares, A., C. A. Kimbrell, B. J. Eitner, and R. D. Vetter. 1999. Evolution of a mitochondrial cytochrome b gene sequence in the species-rich genus *Sebastes* (Teleostei, Scorpaenidae) and its utility in testing the monophyly of the subgenus *Sebastomus*. *Mol. Phylogenet. Evol.* 11:426–440.
- Sanderson, M. J. 1997. A nonparametric approach to estimating divergence times in the absence of rate constancy. *Mol. Biol. Evol.* 14:1218–1231.
- Savolainen, R., and K. Vepsäläinen. 2003. Sympatric speciation through intraspecific social parasitism. *Proc. Natl. Acad. Sci. USA* 100:7169–7174.
- Schemske, D. W. 1983. Limits to specialization and coevolution in plant-animal mutualisms. Pp. 67–109 in M. H. Nitecki, ed. *Coevolution*. Univ. of Chicago Press, Chicago.
- Schubart, C. D., R. Diesel, and S. B. Hedges. 1998. Rapid evolution to terrestrial life in Jamaican crabs. *Nature* 393:363–365.
- Shaw, K. L. 2002. Conflict between nuclear and mitochondrial DNA phylogenies of a recent species radiation: what mtDNA reveals and conceals about modes of speciation in Hawaiian crickets. *Proc. Natl. Acad. Sci. USA* 99:16122–16127.
- Sota, T., and A. P. Vogler. 2001. Incongruence of mitochondrial and nuclear gene trees in the carabid beetles *Ohomopterus*. *Syst. Biol.* 50:39–59.
- Swofford, D. L. 1999. *PAUP*: phylogenetic analysis using parsimony (* and other methods)*. Sinauer Associates, Sunderland, MA.
- Szidat, L. 1940. Beiträge zum aufbau eines natürlichen systems der Trematoden. I. Die entwicklung von Echinocercaria choanophila U. Szidat zu Cathaemasia hians und die ableitung der Fasciolidae von den Echinostomidae. *Z. Parasitenkd.* 11:239–283.
- Thompson, J. N. 1989. Concepts of coevolution. *Trends Ecol. Evol.* 4:179–183.
- Wahlberg, N., R. Oliveira, and J. A. Scott. 2003. Phylogenetic relationships of *Phycodes* butterfly species (Lepidoptera: Nym-

- phalidae): complex mtDNA variation and species delimitations. *Syst. Entomol.* 28:257–273.
- Walsh, P. S., D. A. Metzger, and R. Higuchi. 1991. Chelex-100 as a medium for simple extraction of DNA for PCR-based typing from forensic material. *Biotechniques* 10:506–513.
- Ward, P. S. 1991. Phylogenetic analysis of pseudomyrmecine ants associated with domatia-bearing plants. Pp. 335–352 in C. R. Huxley and D. F. Cutler, eds. *Ant-plant interactions*. Oxford Univ. Press, New York.
- . 1993. Systematic studies on *Pseudomyrmex* acacia-ants (Hymenoptera: Formicidae: Pseudomyrmecinae). *J. Hym. Res.* 2:117–168.
- . 1999. Systematics, biogeography and host plant associations of the *Pseudomyrmex viduus* group (Hymenoptera: Formicidae), *Triplaris*- and *Tachigali*-inhabiting ants. *Zool. J. Linn. Soc.* 126:451–540.
- Weiblen, G. D., and G. L. Bush. 2002. Speciation in fig pollinators and parasites. *Mol. Ecol.* 11:1573–1578.
- Wiens, J. J., and T. A. Penkrot. 2002. Delimiting species using DNA and morphological variation and discordant species limits in spiny lizards (*Sceloporus*). *Syst. Biol.* 51:69–91.
- Wilson, E. O. 1988. The biogeography of the West Indian ants (Hymenoptera: Formicidae). Pp. 214–230 in J. K. Liebherr, ed. *Zoogeography of Caribbean insects*. Cornell Univ. Press, Ithaca, NY.
- Yamane, S. 1997. A list of Bornean ants. Pp. 104–111 in T. Inoue and A. A. Hamid, eds. *General flowering of tropical rainforests in Sarawak*. Center for Ecological Research, Kyoto Univ., Kyoto, Japan.
- Yu, D. W., and D. W. Davidson. 1997. Experimental studies of species-specificity in *Cecropia*-ant relationships. *Ecol. Monogr.* 67:273–294.

Corresponding Editor: O. Pellmyr